

*Alpha Alpha Alpha Alpha Alpha Alpha
Alpha Alpha Alpha Alpha Alpha Alpha
Alpha Alpha Alpha Alpha Alpha Alpha*







HSS DRILL BITS.....	7
Jobber	10
Cobalt Jobber	12
Reduced Shank	18
Sets	20
Bristol Sets.....	29
Long Series.....	30
Extra Long.....	31
Single & Double Ended Panel	33
Stub.....	34
Morse Taper & Adaptor Sleeve.....	36
Step Drills.....	38
Spot Weld & Centre Drills.....	44
Left Hand Drills.....	45
Screw Extractors.....	45
Hex Drill Bit	46
Hex Drill Changable.....	47



COUNTERSINKS.....	49
Countersinks.....	51
Deburrer Countersink	53
Sets	54
Stepped Drill Bits	55
TCT Drill & Countersink.....	56
HSS Drill & Countersink	57
Decking Drill & Countersinks.....	59



THREADING	61
Carbon Taps & Dies - Bulk	62
Carbon Taps & Dies - Carded.....	70
Kits.....	75
HSS Taps - Bulk.....	76
HSS Taps - Carded	80
Cutting Lubricant	81
HSSE Machine Taps - Bulk	82
Wrenches	84



SPECIALTY & MASONRY 87

SPECIALTY	
DiamondMAX Core Bits.....	89
Diamond Core Bits.....	90
Spearpoint Drills.....	91

MASONRY	
Masonry - Straight Shank	94
Multi-Purpose - Straight Shank	96
Multi-Purpose - Hex Shank.....	96
TCT Countersink Depth Gauge	97
2 HEAD CUT - SDS Plus	100
2 HEAD CUT - SDS Plus - TRADE	101
4 HEAD CUT - SDS Plus - ZENTRO®..	102
4 HEAD CUT - SDS Max - ZENTRO®..	103
SDS Max Core Cutter	104
Hollow Core Cutter	105
Chisels - TRADE	106
Plug Anchor - TRADE	106
Dreconnect Adaptor System	107
SDS Max to SDS Plus Adaptor	107



TIMBER 109
 4 Cutter Augers – 4 MAX 111
 Spade Bits – TurboBORE 112
 Extension Bars 113
 Heavy Duty Augers 115
 Scotch Augers 116
 Shipper Augers 117
 Merchandisers 118



MULTI-TOOL BLADES 151
 Multi-Material 155
 Metal 157
 Timber & Hardwood 158
 Specialty 160
 Sanding 161
 Sets 162
 Merchandisers 164



HOLESAWS & HOLE CUTTERS 121
 Bi-Metal Holesaws 125
 Bi-Metal Holesaw Kits 127
 TCT Holesaws 128
 TCT Holesaw Kits 129
 Bristol Bi-Metal Holesaw Kits 130
 Arbors, Sets & Pilot Drills 131
 Pro Lock 133
 HSS Hole Cutters 134
 TCT Hole Cutters 135



CARBIDE BURRS 167
 Cylindrical Smooth End 170
 Cylindrical End Cut 171
 Cylindrical Ball Nose 172
 Ball 173
 Oval 174
 Tree Radius Nose 175
 Tree Pointed Nose 176
 Flame 177
 90° Cone 177
 Included Angle 178
 Pointed Cone 179
 Inverted Cone 179
 Counter Merchandisers 180
 Sets 181



RECIPROCATING BLADES 137
 DESTRUCTOR – Demolition Blades 139
 DESTRUCTOR Set 143
 RIPPA – Timber Blades 145
 SLICER – Metal Blades 147
 General Purpose Set 149



DRIVER BITS 185
 MAXDRIVE Driver Bits 189
 Thunder Zone Driver Bits 193
 Alpha® Driver Bits 201

HSS DRILL BITS

COUNTERSINKS

THREADING

SPECIALTY & MASONRY

TIMBER

HOLESAWS & HOLE CUTTERS

RECIPROCATING BLADES

MULTI-TOOL BLADES

CARBIDE BURRS

DRIVER BITS

PRODUCT INDEX SEE NEXT PAGE >>

REFERENCE TABLES PAGE 215

Product Index

BURR INDEX

Burrs 90° Cone	177
Burrs Ball	173
Burrs Cylindrical Ball Nose	172
Burrs Cylindrical End Cut	171
Burrs Cylindrical Smooth End	170
Burrs Flame	177
Burrs Included Angle	178
Burrs Inverted Cone	179
Burrs Oval	174
Burrs Pointed Cone	179
Burrs Sets	181
Burrs Tree Pointed Nose	176
Burrs Tree Radius Nose	175

COUNTERSINKS INDEX

Countersinks 1 Flute 90°	52
Countersinks 3 Flute 90°	52
Countersinks 3 Flute 90° Quick Release	51
Countersinks 5 Flute 90°	53
Countersinks Cross Hole 90°	53
Countersinks Decking Drill & Countersink	59
Countersinks Depth Gauge	97
Countersinks Drill & Countersink	56
Countersinks Parabolic Drills	59
Countersinks Set - 3 Flute 90°	54
Countersinks Set - Cross Hole 90°	54

DRILLS INDEX

Drills 4 Cutter Auger Bits, 4 MAX	111
Drills Adaptor Sleeve for Morse Taper Shank	37
Drills Auger Bits Heavy Duty	115
Drills Auger Bits Scotch	116
Drills Auger Bits Shipper	117
Drills Centre	44
Drills Diamond - Dry Cut	90
Drills Diamond - Wet & Dry Cut, DiamondMAX	89
Drills Diamond - Wet Cut	90
Drills Extra Long	31
Drills Glass & Tile, Spearpoint	91
Drills Hex Drill Changeable	47
Drills Hex Shank	46
Drills Jobber - Bulk - Imperial	14
Drills Jobber - Bulk - Metric	10
Drills Jobber - Carded - Imperial	15
Drills Jobber - Carded - Metric	12
Drills Jobber - Gauge	17
Drills Left Hand	45
Drills Long Series	30
Drills Masonry - 2 HEAD CUT - SDS Plus	100
Drills Masonry - 2 HEAD CUT - SDS Plus, TRADE	101
Drills Masonry - 4 HEAD CUT - SDS Max, ZENTRO®	103
Drills Masonry - 4 HEAD CUT - SDS Plus, ZENTRO®	102
Drills Masonry - Adaptor, Dreconnect	107
Drills Masonry - Adaptor, SDS Max to SDS Plus	107
Drills Masonry - Chisels - SDS Plus & SDS Max, TRADE	106
Drills Masonry - Core Cutter - SDS Max	104
Drills Masonry - Hollow Core Cutter	105
Drills Masonry - Plug Anchor - SDS Plus, TRADE	106
Drills Masonry - Straight Shank	94
Drills Morse Taper Shank MT1	36



Drills Multi-Purpose - Hex Shank	96
Drills Multi-Purpose - Straight Shank	96
Drills Panel Double End	33
Drills Panel Single End	33
Drills Reduced Shank	18
Drills Screw Extractors	45
Drills Set - Diamond - Wet & Dry Cut, <i>DiamondMAX</i>	89
Drills Sets	24
Drills Sets - 4 Cutter Auger Bits, <i>4 MAX</i>	111
Drills Sets - Hex Shank	46
Drills Sets - Masonry - 2 HEAD CUT - SDS Plus	100
Drills Sets - Masonry - 4 HEAD CUT - SDS Plus, <i>ZENTRO®</i>	102
Drills Sets - Masonry - Straight Shank	95
Drills Sets - Multi-Purpose - Hex Shank	96
Drills Sets - Reduced Shank	26
Drills Sets - Spade Bits, <i>TurboBORE</i>	112
Drills Sets - Step Drills 2 Flute Straight	40
Drills Sets, <i>Bristol</i>	29
Drills Sets, <i>SlimBox™</i>	22
Drills Sets, <i>TUFFBOX™</i>	20
Drills Spade Bits, <i>TurboBORE</i>	112
Drills Spot Weld	44
Drills Step Drills 2 Flute Spiral	41
Drills Step Drills 2 Flute Straight	40
Drills Step Drills 4 Flute Spiral	42
Drills Stepped	55
Drills Stub	34

DRIVER BITS INDEX

Driver Bits Bit Holders	210
Driver Bits Bit Holders, <i>Thunder Zone</i>	196
Driver Bits Hex	206
Driver Bits Hex Security	207
Driver Bits Hex to Square Adaptor	209
Driver Bits Hex to Square Adaptor, <i>Thunder Zone</i>	196
Driver Bits Hex, <i>MaxDrive</i>	191
Driver Bits Hex, <i>Thunder Zone</i>	196
Driver Bits Magnetic Socket (Square to Hex Adaptor)	209
Driver Bits Nutsetter	209
Driver Bits Nutsetter, <i>MaxDrive</i>	191
Driver Bits Nutsetter, <i>Thunder Zone</i>	196
Driver Bits Phillips®	202
Driver Bits Phillips®, <i>MaxDrive</i>	191
Driver Bits Phillips®, <i>Thunder Zone</i>	195
Driver Bits Pin Security	207
Driver Bits Pozidriv®	204
Driver Bits Pozidriv®, <i>MaxDrive</i>	191
Driver Bits Pozidriv®, <i>Thunder Zone</i>	195
Driver Bits Screwdriver Handle	210
Driver Bits Set, <i>Thunder Zone</i>	197
Driver Bits Sets	211
Driver Bits Slotted	206
Driver Bits Slotted, <i>Thunder Zone</i>	196
Driver Bits Square	205
Driver Bits Square Security	205
Driver Bits Square, <i>MaxDrive</i>	191
Driver Bits Square, <i>Thunder Zone</i>	195
Driver Bits Torx®	208
Driver Bits Torx® Security	208
Driver Bits Torx®, <i>Thunder Zone</i>	195

Driver Bits Tri-Lobular	207
Driver Bits Tri-Wing®	207

EXTENSIONS INDEX

Extensions Grub Screw	113
Extensions Grub Screw Heavy Duty	113
Extensions Quick Release	113

HOLESAWS & HOLE CUTTERS INDEX

Hole Cutters HSS Replacement Pilot Drills	134
Hole Cutters HSS Thin Sheet	134
Hole Cutters Kit - HSS Thin Sheet	134
Hole Cutters Kit - TCT	135
Hole Cutters TCT	135
Hole Cutters TCT Replacement Pilot Drills	135
Hole Cutters TCT Replacement Springs	135
Holesaws Arbor Adaptor	131
Holesaws Arbors	131
Holesaws Bi-Metal, <i>White Pointer</i>	125
Holesaws Kits - Bi-Metal, <i>Bristol</i>	130
Holesaws Kits - Bi-Metal, <i>White Pointer</i>	127
Holesaws Kits - Quick Change Adaptors, <i>Pro Lock</i>	133
Holesaws Kits - TCT Multi-Purpose	129
Holesaws Pilot Drills	131
Holesaws Pilot Drills, <i>Pro Lock</i>	133
Holesaws Quick Change Adaptors, <i>Pro Lock</i>	133
Holesaws TCT Multi-Purpose	128

LUBRICANT INDEX

Lubricant C.D.T Cutting Lubricant	16
--	----

MERCHANDISERS INDEX

Merchandisers Auger Bits Heavy Duty	119
Merchandisers Burrs	180
Merchandisers Driver Bits	212
Merchandisers Driver Bits, <i>Thunder Zone</i>	197
Merchandisers Multi-Tools	164
Merchandisers Spade Bits, <i>TurboBORE</i>	118
Merchandisers Step Drills	43

MULTI-TOOLS INDEX

Multi-Tools Coarse Tooth - Hardwood Blades	159
Multi-Tools Coarse Tooth - Timber Blades	158
Multi-Tools Fine Tooth - Timber Blades	158
Multi-Tools HSS Segment - Multi-Material Blades	156
Multi-Tools Japanese Tooth - Timber Blades	160
Multi-Tools Metal Buster - Metal Blades	157
Multi-Tools Nail Buster - Multi-Material Blades	155
Multi-Tools Sanding Pad	161
Multi-Tools Sanding Sheets	161
Multi-Tools Sets - Multi-Material Blades	162
Multi-Tools Surecut "Präzision" - Multi-Material Blades	156
Multi-Tools Tungsten Carbide - Segment Blades	160

RECIP BLADES INDEX

Recip Blades Demolition - Metal & Timber, <i>Destructor</i>	142
Recip Blades Demolition - Metal, <i>Destructor</i>	140
Recip Blades Demolition - Wood & Nails, <i>Destructor</i>	139
Recip Blades Metal, <i>Slicer</i>	147

Recip Blades Set - Demolition, <i>Destructor</i>	143
Recip Blades Set - General Purpose	149
Recip Blades Timber, <i>Rippa</i>	145

THREADING INDEX

Threading C.D.T Cutting Lubricant	81
Threading Carbon Dies - Bulk - BSF	67
Threading Carbon Dies - Bulk - BSPF	69
Threading Carbon Dies - Bulk - BSPT	69
Threading Carbon Dies - Bulk - BSW	67
Threading Carbon Dies - Bulk - Metric Coarse	63
Threading Carbon Dies - Bulk - Metric Fine	63
Threading Carbon Dies - Bulk - NPT	69
Threading Carbon Dies - Bulk - UNC	65
Threading Carbon Dies - Bulk - UNF	65
Threading Carbon Dies - Carded - BSW	73
Threading Carbon Dies - Carded - Metric Coarse	71
Threading Carbon Dies - Carded - Metric Fine	71
Threading Carbon Dies - Carded - UNC	73
Threading Carbon Dies - Carded - UNF	73
Threading Carbon Taps - Bulk - BSF	66
Threading Carbon Taps - Bulk - BSPF	68
Threading Carbon Taps - Bulk - BSPT	68
Threading Carbon Taps - Bulk - BSW	66
Threading Carbon Taps - Bulk - Metric Coarse	62
Threading Carbon Taps - Bulk - Metric Fine	62
Threading Carbon Taps - Bulk - NPSF	68
Threading Carbon Taps - Bulk - NPT	68
Threading Carbon Taps - Bulk - UNC	64
Threading Carbon Taps - Bulk - UNF	64
Threading Carbon Taps - Carded - BSPF	74
Threading Carbon Taps - Carded - BSPT	74
Threading Carbon Taps - Carded - BSW	72
Threading Carbon Taps - Carded - Metric Coarse	70
Threading Carbon Taps - Carded - Metric Fine	70
Threading Carbon Taps - Carded - NPT	74
Threading Carbon Taps - Carded - UNC	72
Threading Carbon Taps - Carded - UNF	72
Threading HSS Taps - Bulk - BSF	78
Threading HSS Taps - Bulk - BSPF	79
Threading HSS Taps - Bulk - BSPT	79
Threading HSS Taps - Bulk - BSW	78
Threading HSS Taps - Bulk - Metric Coarse	76
Threading HSS Taps - Bulk - Metric Coarse Oversize/Galvanising	76
Threading HSS Taps - Bulk - Metric Fine	76
Threading HSS Taps - Bulk - NPSF	79
Threading HSS Taps - Bulk - NPT	79
Threading HSS Taps - Bulk - UNC	77
Threading HSS Taps - Bulk - UNF	77
Threading HSS Taps - Carded - BSW	80
Threading HSS Taps - Carded - Metric Coarse	80
Threading HSS Taps - Carded - UNC	80
Threading HSS Taps - Carded - UNF	80
Threading HSSE Taps - Bulk - Metric Coarse	82
Threading HSSE Taps - Bulk - Metric Fine	82
Threading HSSE Taps - Bulk - UNC	83
Threading HSSE Taps - Bulk - UNF	83
Threading Kits - Carbon Taps & Dies	75
Threading Wrenches	84





HSS Drill Bits

Jobber	10
Cobalt Jobber	12
Reduced Shank	18
Sets	20
Bristol Sets	29
Long Series	30
Extra Long	31
Single & Double Ended Panel	33
Stub	34
Morse Taper & Adaptor Sleeve	36
Step Drills	38
Spot Weld & Centre Drills	44
Left Hand Drills	45
Screw Extractors	45
Hex Drill Bit	46
Hex Drill Changable	47

HSS Drill Bits



Available in both bulk and carded in all ranges

Available in both bulk and carded in selected ranges

GOLD Series

Ideal for the widest range of materials:
Steel, wood, plastic and stainless steel



135° split point
cuts faster and
reduces wandering

- Titanium nitride coating reduces heat and increases lubricity for extended life
- Independent controlled testing has proved that the Alpha GOLD Series drills outperform other drills on the market by up to 30%

SILVER Series

Ideal for general purpose drilling:
Steel, wood and plastic



118° split point
reduces wandering



Available in bulk
in selected ranges



Available in both bulk and
carded in selected ranges



Available in carded

BLACK Series

Ideal for hard metal drilling:
Hard ferrous metals, wood and plastic



118° split point
reduces wandering

- Black oxide coating maximises lubricant hold, therefore assisting chip flow and heat dissipation
- Corrosion resistant finish
- Coolant recommended when drilling hard metals

COBALT Series

Ideal for heavy duty drilling:
Stainless steel, high tensile steel and cast iron



135° split point
cuts faster and
reduces wandering

- Fully ground HSS Cobalt increases strength and drill life

Reduced Shank

Ideal for the widest range of materials:
Steel, wood, plastic and stainless steel



118° split point,
ideal for drilling
into pilot holes

- Black oxide coating maximises lubricant hold, therefore assisting chip flow and heat dissipation
- 3 flats on shank, prevents slippage in chuck

Jobber Drills

BULK
Supplied in hangable plastic pack



Reduced shank



10 PACK
Sizes 0.3 – 6.9



5 PACK
Sizes 7.0 – 9.9

Also available:
10.0, 10.5, 11.0, 11.5,
12.0, 12.5 & 13.0



1 PCE
Sizes 10.0 – 13.5
1 per pack



BULK JOBBER

METRIC

Ø mm	OAL mm	FL mm	Pack QTY	GOLD	SILVER	BLACK
0.3	19	4	10	9LM003		
0.4	20	5	10	9LM004		
0.5	22	6	10	9LM005		
0.58	30	9	10	9LM0058		
0.6	24	7	10	9LM006		
0.7	28	9	10	9LM007		
0.8	30	10	10	9LM008		
0.9	32	11	10	9LM009		
1.0	34	12	10	9LM010	9LM010S	9LM010B
1.1	36	14	10	9LM011		
1.2	38	16	10	9LM012		
1.3	38	16	10	9LM013		
1.4	40	18	10	9LM014		
1.5	40	18	10	9LM015	9LM015S	9LM015B
1.6	43	20	10	9LM016		
1.7	43	20	10	9LM017		
1.8	46	22	10	9LM018		
1.9	46	22	10	9LM019		
2.0	49	24	10	9LM020	9LM020S	9LM020B
2.1	49	24	10	9LM021		
2.2	53	27	10	9LM022		
2.25	53	27	10	9LM0225		
2.3	53	27	10	9LM023		
2.4	57	30	10	9LM024		
2.5	57	30	10	9LM025	9LM025S	9LM025B
2.6	57	30	10	9LM026		
2.7	61	33	10	9LM027		
2.75	61	33	10	9LM0275		
2.8	61	33	10	9LM028		
2.9	61	33	10	9LM029		
3.0	61	36	10	9LM030	9LM030S	9LM030B
3.1	65	36	10	9LM031		
3.2	65	36	10	9LM032	9LM032S	
3.3	65	36	10	9LM033	9LM033S	
3.4	70	39	10	9LM034		
3.5	70	39	10	9LM035	9LM035S	9LM035B
3.6	70	39	10	9LM036		
3.7	70	39	10	9LM037		
3.8	75	43	10	9LM038		
3.9	75	43	10	9LM039		
4.0	75	43	10	9LM040	9LM040S	9LM040B
4.1	75	43	10	9LM041		
4.2	75	43	10	9LM042	9LM042S	
4.3	80	47	10	9LM043		
4.4	80	47	10	9LM044		
4.5	80	47	10	9LM045	9LM045S	9LM045B
4.6	80	47	10	9LM046		
4.7	80	47	10	9LM047		
4.8	86	52	10	9LM048		



BULK JOBBER

METRIC

						
ϕ mm	OAL mm	FL mm	Pack QTY	GOLD	SILVER	BLACK
4.9	86	52	10	9LM049	9LM049S	
5.0	86	52	10	9LM050	9LM050S	9LM050B
5.1	86	52	10	9LM051	9LM051S	
5.2	86	52	10	9LM052		
5.3	86	52	10	9LM053		
5.4	93	57	10	9LM054		
5.5	93	57	10	9LM055	9LM055S	9LM055B
5.6	93	57	10	9LM056		
5.7	93	57	10	9LM057		
5.8	93	57	10	9LM058		9LM058B
5.9	93	57	10	9LM059		
6.0	93	57	10	9LM060	9LM060S	9LM060B
6.1	101	63	10	9LM061		
6.15	101	63	10	9LM0615		
6.2	101	63	10	9LM062		
6.3	101	63	10	9LM063		
6.4	101	63	10	9LM064		
6.5	101	63	10	9LM065	9LM065S	9LM065B
6.6	101	63	10	9LM066		
6.7	101	63	10	9LM067		
6.8	109	69	10	9LM068		
6.9	109	69	10	9LM069		
7.0	109	69	5	9LM070	9LM070S	9LM070B
7.1	109	69	5	9LM071		
7.2	109	69	5	9LM072		
7.3	109	69	5	9LM073		
7.4	109	69	5	9LM074		
7.5	109	69	5	9LM075	9LM075S	9LM075B
7.6	117	75	5	9LM076		
7.7	117	75	5	9LM077		
7.8	117	75	5	9LM078		
7.9	117	75	5	9LM079		
8.0	117	75	5	9LM080	9LM080S	9LM080B
8.1	117	75	5	9LM081		
8.2	117	75	5	9LM082		
8.3	117	75	5	9LM083		
8.4	117	75	5	9LM084		
8.5	117	75	5	9LM085	9LM085S	9LM085B
8.6	125	81	5	9LM086		
8.7	125	81	5	9LM087		
8.8	125	81	5	9LM088		
8.9	125	81	5	9LM089		
9.0	125	81	5	9LM090	9LM090S	9LM090B
9.1	125	81	5	9LM091		
9.2	125	81	5	9LM092		
9.3	125	81	5	9LM093		
9.4	125	81	5	9LM094		
9.5	125	81	5	9LM095	9LM095S	9LM095B
9.6	125	81	5	9LM096		

BULK JOBBER

METRIC

						
ϕ mm	OAL mm	FL mm	Pack QTY	GOLD	SILVER	BLACK
9.7	133	87	5	9LM097		
9.8	133	87	5	9LM098		
9.9	133	87	5	9LM099		
10.0	133	87	5	9LM100-5		
	133	87	1	9LM100	9LM100S	9LM100B
10.1	133	87	1	9LM101		
10.2	133	87	1	9LM102		
10.3	133	87	1	9LM103		
10.4	133	87	1	9LM104		
	133	87	5	9LM105-5		
10.5	133	87	1	9LM105	9LM105S	9LM105B
	133	87	1	9LM105R	REDUCED SHANK*	
10.6	133	87	1	9LM106		
10.7	142	94	1	9LM107		
10.8	142	94	1	9LM108		
10.9	142	94	1	9LM109		
	142	94	5	9LM110-5		
11.0	142	94	1	9LM110	9LM110S	9LM110B
	142	94	1	9LM110R	REDUCED SHANK*	
11.1	142	94	1	9LM111		
11.2	142	94	1	9LM112		
11.3	142	94	1	9LM113		
11.4	142	94	1	9LM114		
	142	94	5	9LM115-5		
11.5	142	94	1	9LM115	9LM115S	9LM115B
	142	94	1	9LM115R	REDUCED SHANK*	
11.6	142	94	1	9LM116		
11.7	142	94	1	9LM117		
11.8	142	94	1	9LM118		
11.9	151	101	1	9LM119		
	151	101	5	9LM120-5		
12.0	151	101	1	9LM120	9LM120S	9LM120B
	151	101	1	9LM120R	REDUCED SHANK*	
12.1	151	101	1	9LM121		
12.2	151	101	1	9LM122		
12.3	151	101	1	9LM123		
12.4	151	101	1	9LM124		
	151	101	5	9LM125-5		
12.5	151	101	1	9LM125	9LM125S	9LM125B
	151	101	1	9LM125R	REDUCED SHANK*	
12.6	151	101	1	9LM126		
12.7	151	101	1	9LM127		
12.8	151	101	1	9LM128		
12.9	151	101	1	9LM129		
	151	101	5	9LM130-5		
13.0	151	101	1	9LM130	9LM130S	9LM130B
	151	101	1	9LM130R	REDUCED SHANK*	
13.5	160	101	1	9LM135		9LM135B

*Reduced shank = 10.0mm (3/8")

Jobber Drills – Metric

Jobber Drills

CARDED & TRADE PACK
Supplied in
hangable card



Reduced shank



CARDED JOBBER

METRIC			GOLD		SILVER	COBALT	Suits Tapping Thread
Ø mm	OAL mm	FL mm	Carded 2 PCE	Trade Pack** 10 PACK	Carded 2 PCE	Carded 1 PCE	
1.0	34	12	C9LM010		C9LM010S	9LM010CO	
1.5	40	18	C9LM015	C9LM015TP	C9LM015S	9LM015CO	
1.6	43	20	C9LM016				M2 (MC)
2.0	49	24	C9LM020	C9LM020TP	C9LM020S	9LM020CO	
2.5	57	30	C9LM025	C9LM025TP	C9LM025S	9LM025CO	
2.6	57	30	C9LM026				
3.0	61	36	C9LM030	C9LM030TP	C9LM030S	9LM030CO	

Ø mm	OAL mm	FL mm	Carded 1 PCE	Trade Pack** 10 PACK	Carded 1 PCE	Carded 1 PCE	Suits Tapping Thread
3.2	65	36	C9LM032		C9LM032S		
3.3	65	36	C9LM033		C9LM033S		M4 (MC)
3.5	70	39	C9LM035		C9LM035S	9LM035CO	#8 (UNF) & M4 (MF)
3.7	70	39	C9LM037				
3.9	75	43	C9LM039				
4.0	75	43	C9LM040	C9LM040TP	C9LM040S	9LM040CO	
4.1	75	43	C9LM041				#10 (UNF)
4.2	75	43	C9LM042		C9LM042S		M5 (MC)
4.5	80	47	C9LM045		C9LM045S	9LM045CO	#12 (UNC)

Ø mm	OAL mm	FL mm	Carded 1 PCE	Trade Pack** 5 PACK	Carded 1 PCE	Carded 1 PCE	Suits Tapping Thread
5.0	86	52	C9LM050	C9LM050TP	C9LM050S	9LM050CO	
5.1	86	52	C9LM051		C9LM051S		1/4" (BSW)
5.3	86	52	C9LM053				M6 (MF)
5.5	93	57	C9LM055		C9LM055S	9LM055CO	1/4" (UNF)
5.6	93	57				9LM056CO	
5.8	93	57				9LM058CO	
6.0	93	57	C9LM060	C9LM060TP	C9LM060S	9LM060CO	
6.5	101	63	C9LM065	C9LM065TP	C9LM065S	9LM065CO	5/16" (BSW)
6.6	101	63	C9LM066				5/16" (UNC)
6.8	109	69	C9LM068				M8 (MC)
6.9	109	69	C9LM069				5/16" (UNF)
7.0	109	69	C9LM070		C9LM070S	9LM070CO	
7.5	109	69	C9LM075		C9LM075S	9LM075CO	
8.0	117	75	C9LM080		C9LM080S	9LM080CO	
8.4	117	75	C9LM084				
8.5	117	75	C9LM085		C9LM085S	9LM085CO	M10 (MC) & 3/8" (UNF)
8.8	125	81	C9LM088				M10 (MF)
9.0	125	81	C9LM090		C9LM090S	9LM090CO	
9.4	125	81	C9LM094				7/16" (UNC)
9.5	125	81	C9LM095		C9LM095S	9LM095CO	
9.8	133	87	C9LM098				
10.0	133	87	C9LM100		C9LM100S	9LM100CO	
10.2	133	87	C9LM102				M12 (MC)

CARDED JOBBER

METRIC			GOLD		SILVER	COBALT	Suits Tapping Thread
Ø mm	OAL mm	FL mm	Carded 1 PCE	Trade Pack** 5 PACK	Carded 1 PCE	Carded 1 PCE	
10.5	133	87	C9LM105		C9LM105S	9LM105CO	1/2" (BSW)
	133	87	C9LM105R*	REDUCED SHANK			
10.8	142	94	C9LM108				1/2" (UNC)
11.0	142	94	C9LM110		C9LM110S	9LM110CO	
	142	94	C9LM110R*	REDUCED SHANK			
11.5	142	94	C9LM115		C9LM115S	9LM115CO	1/2" (UNF)
	142	94	C9LM115R*	REDUCED SHANK			
12.0	151	101	C9LM120		C9LM120S	9LM120CO	
	151	101	C9LM120R*	REDUCED SHANK			
12.5	151	101	C9LM125		C9LM125S	9LM125CO	M14 (MF)
	151	101	C9LM125R*	REDUCED SHANK			
13.0	151	101	C9LM130		C9LM130S	9LM130CO	
	151	101	C9LM130R*	REDUCED SHANK			
13.5	152	86	C9LM135R*	REDUCED SHANK			

*Reduced shank = 10.0mm (3/8") **New trade packs pending

CARDED
Supplied in
hangable card



2 PCE
GOLD & SILVER
Sizes 1.0 - 3.0mm



1 PCE: GOLD & SILVER
Sizes 3.2 - 13.0mm
1 PCE: COBALT All sizes

CARDED
TRADE PACKS
Supplied in
hangable card

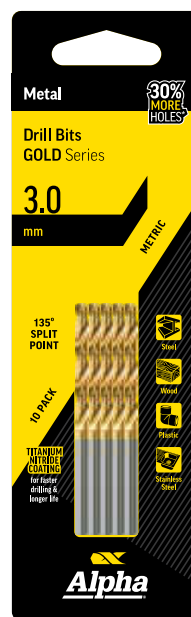

10 PACK
Sizes 1.5 - 4mm



5 PACK
Sizes 5 - 6.5mm

Jobber Drills - Imperial

Jobber Drills

BULK
Supplied in
hangable
plastic pack



Reduced shank



10 PACK
Sizes 1/64" - 9/32"



5 PACK
Sizes 19/64" - 25/64"

Also available:
13/32", 27/64", 29/64",
31/64" & 1/2"



1 PCE
Sizes 13/32" - 1/2"

BULK JOBBER IMPERIAL

Ø inches	Ø mm	OAL mm	FL mm	Pack QTY	IMPERIAL		
					GOLD	SILVER	BLACK
1/64	0.40	20	5	10	9LI164		9LI164B
1/32	0.79	30	10	10	9LI132		9LI132B
3/64	1.19	44	19	10	9LI364		9LI364B
1/16	1.59	48	23	10	9LI116	9LI116S	9LI116B
5/64	1.98	50	25	10	9LI564	9LI564S	9LI564B
3/32	2.38	54	30	10	9LI332	9LI332S	9LI332B
7/64	2.78	67	38	10	9LI764	9LI764S	9LI764B
1/8	3.17	70	42	10	9LI18	9LI18S	9LI18B
9/64	3.57	73	41	10	9LI964	9LI964S	9LI964B
5/32	3.97	79	53	10	9LI532	9LI532S	9LI532B
11/64	4.37	82	54	10	9LI1164	9LI1164S	9LI1164B
3/16	4.76	89	59	10	9LI316	9LI316S	9LI316B
13/64	5.16	92	62	10	9LI1364	9LI1364S	9LI1364B
7/32	5.56	95	63	10	9LI732	9LI732S	9LI732B
15/64	5.95	98	66	10	9LI1564	9LI1564S	9LI1564B
1/4	6.35	101	70	10	9LI14	9LI14S	9LI14B
17/64	6.75	104	73	10	9LI1764	9LI1764S	9LI1764B
9/32	7.14	110	75	10	9LI932	9LI932S	9LI932B
19/64	7.54	111	78	5	9LI1964	9LI1964S	9LI1964B
5/16	7.94	114	81	5	9LI516	9LI516S	9LI516B
21/64	8.33	117	85	5	9LI2164	9LI2164S	9LI2164B
11/32	8.73	121	87	5	9LI1132	9LI1132S	9LI1132B
23/64	9.13	124	89	5	9LI2364	9LI2364S	9LI2364B
3/8	9.53	125	81	5	9LI38	9LI38S	9LI38B
25/64	9.92	130	95	5	9LI2564	9LI2564S	9LI2564B
13/32	10.32	133	89	5	9LI1332-5		
	10.32	133	89	1	9LI1332	9LI1332S	9LI1332B
	10.32	133	89	1	9LI1332R*	REDUCED SHANK	
27/64	10.72	133	94	5	9LI2764-5		
	10.72	133	94	1	9LI2764	9LI2764S	9LI2764B
	10.72	133	94	1	9LI2764R*	REDUCED SHANK	
7/16	11.11	140	103	1	9LI716	9LI716S	9LI716B
	11.11	140	103	1	9LI716R*	REDUCED SHANK	
29/64	11.51	143	106	5	9LI2964-5		
	11.51	143	106	1	9LI2964	9LI2964S	9LI2964B
	11.51	143	106	1	9LI2964R*	REDUCED SHANK	
15/32	11.91	146	110	1	9LI1532	9LI1532S	9LI1532B
	11.91	146	110	1	9LI1532R*	REDUCED SHANK	
31/64	12.30	149	111	5	9LI3164-5		
	12.30	149	111	1	9LI3164	9LI3164S	9LI3164B
	12.30	149	111	1	9LI3164R*	REDUCED SHANK	
1/2	12.70	156	114	5	9LI12-5		
	12.70	156	114	1	9LI12	9LI12S	9LI12B
	12.70	156	114	1	9LI12R*	REDUCED SHANK	

*Reduced shank = 3/8" (10.0mm)

CARDED JOBBER

IMPERIAL				GOLD		SILVER	COBALT
Ø inches	Ø mm	OAL mm	FL mm	Carded 2 PCE	Trade Pack** 10 PACK	Carded 2 PCE	Carded 1 PCE
1/16	1.59	48	23	C9LI116	C9LI116TP	C9LI116S	9LI116CO
5/64	1.98	50	25	C9LI564	C9LI564TP	C9LI564S	9LI564CO
3/32	2.38	54	30	C9LI332	C9LI332TP	C9LI332S	9LI332CO
7/64	2.78	67	38	C9LI764	C9LI764TP	C9LI764S	9LI764CO
1/8	3.17	70	42	C9LI118	C9LI118TP	C9LI118S	9LI118CO

Ø inches	Ø mm	OAL mm	FL mm	Carded 1 PCE	Trade Pack** 10 PACK	Carded 1 PCE	Carded 1 PCE
9/64	3.57	73	41	C9LI964	C9LI964TP	C9LI964S	9LI964CO
5/32	3.97	79	53	C9LI532	C9LI532TP	C9LI532S	9LI532CO
11/64	4.37	82	54	C9LI1164		C9LI1164S	9LI1164CO

Ø inches	Ø mm	OAL mm	FL mm	Carded 1 PCE	Trade Pack** 5 PACK	Carded 1 PCE	Carded 1 PCE
3/16	4.76	89	59	C9LI316	C9LI316TP	C9LI316S	9LI316CO
13/64	5.16	92	62	C9LI1364		C9LI1364S	9LI1364CO
7/32	5.56	95	63	C9LI732		C9LI732S	9LI732CO
15/64	5.95	98	66	C9LI1564		C9LI1564S	9LI1564CO
1/4	6.35	101	70	C9LI114	C9LI114TP	C9LI114S	9LI114CO
17/64	6.75	104	73	C9LI1764		C9LI1764S	9LI1764CO
9/32	7.14	110	75	C9LI932		C9LI932S	9LI932CO
19/64	7.54	111	78	C9LI1964		C9LI1964S	9LI1964CO
5/16	7.94	114	81	C9LI516		C9LI516S	9LI516CO
21/64	8.33	117	85	C9LI2164		C9LI2164S	9LI2164CO
11/32	8.73	121	87	C9LI1132		C9LI1132S	9LI1132CO
23/64	9.13	124	89	C9LI2364		C9LI2364S	9LI2364CO
3/8	9.53	125	81	C9LI38		C9LI38S	9LI38CO
25/64	9.92	130	95	C9LI2564		C9LI2564S	9LI2564CO
13/32	10.32	133	89	C9LI1332		C9LI1332S	9LI1332CO
	10.32	133	89	C9LI1332R*	REDUCED SHANK		
27/64	10.72	133	94	C9LI2764		C9LI2764S	9LI2764CO
	10.72	133	94	C9LI2764R*	REDUCED SHANK		
7/16	11.11	140	103	C9LI716		C9LI716S	9LI716CO
	11.11	140	103	C9LI716R*	REDUCED SHANK		
29/64	11.51	143	106	C9LI2964		C9LI2964S	9LI2964CO
	11.51	143	106	C9LI2964R*	REDUCED SHANK		
15/32	11.91	146	110	C9LI1532		C9LI1532S	9LI1532CO
	11.91	146	110	C9LI1532R*	REDUCED SHANK		
31/64	12.30	149	111	C9LI3164		C9LI3164S	9LI3164CO
	12.30	149	111	C9LI3164R*	REDUCED SHANK		
1/2	12.70	156	114	C9LI112		C9LI112S	9LI112CO
	12.70	156	114	C9LI112R*	REDUCED SHANK		

*Reduced shank = 3/8" (10.0mm) **New trade packs pending



CARDED
Supplied in hangable card
2 PCE: Sizes 1/16" - 1/8"
1 PCE: Sizes 9/64" - 1/2"



CARDED - TRADE PACKS
Supplied in hangable card
10 PACK: Sizes 1/16" - 5/32"
5 PACK: Sizes 3/16" & 1/4"



C.D.T Cut.Drill.Tap Cutting Lubricant





Alpha C.D.T is formulated for extreme cutting performance when tapping, drilling or reaming into all metals, including hardened steel and titanium. Special additives reduce friction, extend tool life and provide excellent surface finish. Alpha C.D.T is water soluble, safe and easy to use.

- 250ml squeeze bottle
- Improves overall tool performance
- Non-flammable
- Environmentally safe
- Biodegradable ingredients
- Easy to use and clean up

Cutting Lubricant
250 ml

Code: ATL005

Jobber Drills

BULK & CARDED									
GAUGE					GOLD	SILVER	BLACK	COBALT	
#	Ø	Ø mm	OAL mm	FL mm	For Rivet	Bulk 10 PACK	Bulk 10 PACK	Bulk 10 PACK	Carded 1 PCE
# 40	2.49	56	31						9LG40CO
# 41	2.44	60	36		9LG41				
# 36	2.71	64	37		9LG36				
# 35	2.79	67	38		9LG35				
# 31	3.05	70	40		9LG31				
# 30	3.26	70	42	1/8"	9L30	9L30S	9L30B	9LG30CO	
# 29	3.45	73	44		9LG29				
# 28	3.57	73	44		9LG28				
# 26	3.73	76	48		9LG26				
# 25	3.80	75	43		9LG25				
# 21	4.04	83	54		9LG21				
# 20	4.09	80	54	4mm & 5/32"	9L20	9L20S		9LG20CO	
# 19	4.22	83	54		9LG19				
# 18	4.30	83	54		9LG18				
# 15	4.57	86	56		9LG15				
# 11	4.85	89	59	3/16"	9L11	9L11S			
# 7	5.11	92	62		9LG7				



BULK - 10 PACK
Supplied in hangable plastic pack

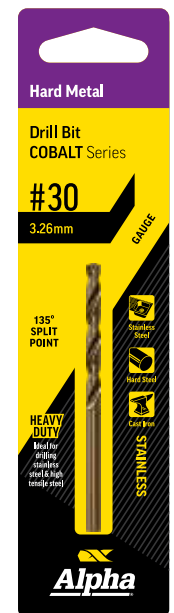

CARDED - 1 PCE
Supplied in hangable card



Metric

Reduced Shank Drills – Metric



Sizes: 10.5 – 13.5mm
Gold Series

- 135° split point cuts faster and reduces wandering
- TiN coating, reduces heat and increases lubricity for extended life
- Fully ground M2 HSS

30% MORE HOLES

BULK – 1 PCE

Supplied in hangable plastic pack

CARDED – 1 PCE

Supplied in hangable card



Sizes: 14.0mm – 32.0mm

- 118° split point, ideal for drilling into pilot holes
- Black oxide coating maximises lubricant hold, therefore assisting chip flow and heat dissipation
- 3 flats on shank, prevents slippage in chuck

HEAVY DUTY

Full length ground from a single piece of HSS, eliminating breakage

CARDED – 1 PCE

Supplied in hangable card

BULK & CARDED

METRIC

Ø mm	OAL mm	FL mm	Reduced Shank mm	GOLD		BLACK & SILVER
				Bulk 1 PCE	Carded 1 PCE	Carded 1 PCE
10.5	133	87	10.0	9LM105R	C9LM105R	
11.0	142	94	10.0	9LM110R	C9LM110R	
11.5	142	94	10.0	9LM115R	C9LM115R	
12.0	151	101	10.0	9LM120R	C9LM120R	
12.5	151	101	10.0	9LM125R	C9LM125R	
13.0	151	101	10.0	9LM130R	C9LM130R	
13.5	152	86	10.0		C9LM135R	
14.0	152	86	10.0			9LM140R
	152	86	12.7			9LM140R12
14.5	152	86	12.7			9LM145R
15.0	152	86	12.7			9LM150R
15.5	152	86	12.7			9LM155R
16.0	152	86	12.7			9LM160R
16.5	152	86	12.7			9LM165R
17.0	152	86	12.7			9LM170R
17.5	152	86	12.7			9LM175R*
18.0	152	86	12.7			9LM180R
18.5	152	86	12.7			9LM185R
19.0	152	86	12.7			9LM190R
19.5	152	86	12.7			9LM195R
20.0	152	86	12.7			9LM200R
20.5	152	86	12.7			9LM205R
21.0	152	86	12.7			9LM210R
21.5	152	86	12.7			9LM215R
22.0	152	86	12.7			9LM220R
22.5	152	86	12.7			9LM225R
23.0	152	86	12.7			9LM230R
23.5	152	86	12.7			9LM235R
24.0	152	86	12.7			9LM240R
24.5	152	86	12.7			9LM245R
25.0	152	86	12.7			9LM250R
26.0	152	86	12.7			9LM260R
27.0	152	86	12.7			9LM270R
28.0	152	86	12.7			9LM280R
29.0	152	86	12.7			9LM290R
30.0	152	86	12.7			9LM300R
32.0	152	86	12.7			9LM320R

*17.0mm also available in COBALT Series (code: 9LM175RCO)

Reduced Shank Drills – Imperial

BULK & CARDED

IMPERIAL					GOLD		BLACK & SILVER
Ø inches	Ø mm	OAL mm	FL mm	Reduced Shank inches	Bulk	Carded	Carded
					1 PCE	1 PCE	
13/32	10.32	133	89	3/8	9LI1332R	C9LI1332R	
27/64	10.72	133	94	3/8	9LI2764R	C9LI2764R	
7/16	11.11	140	103	3/8	9LI716R	C9LI716R	
29/64	11.51	143	106	3/8	9LI2964R	C9LI2964R	
15/32	11.91	146	110	3/8	9LI1532R	C9LI1532R	
31/64	12.30	149	111	3/8	9LI3164R	C9LI3164R	
1/2	12.70	152	114	3/8	9LI12R	C9LI12R	
33/64	13.10	152	86	3/8			9LI3364R
17/32	13.49	152	86	1/2			9LI1732R
35/64	13.89	152	86	3/8			9LI3564R
9/16	14.29	152	86	3/8			9LI916R38
	14.29	152	86	1/2			9LI916R
37/64	14.68	152	86	1/2			9LI3764R
19/32	15.08	152	86	1/2			9LI1932R
39/64	15.48	152	86	1/2			9LI3964R
5/8	15.88	152	86	3/8			9LI58R38
	15.88	152	86	1/2			9LI58R
41/64	16.27	152	86	1/2			9LI4164R
21/32	16.67	152	86	1/2			9LI2132R
43/64	17.06	152	86	1/2			9LI4364R
11/16	17.46	152	86	1/2			9LI1116R
45/64	17.86	152	86	1/2			9LI4564R
23/32	18.26	152	86	1/2			9LI2332R
3/4	19.05	152	86	1/2			9LI34R
49/64	19.45	152	86	1/2			9LI4964R
25/32	19.84	152	86	1/2			9LI2532R
51/64	20.24	152	86	1/2			9LI5164R
13/16	20.64	152	86	1/2			9LI1316R
53/64	21.03	152	86	1/2			9LI5364R
27/32	21.43	152	86	1/2			9LI2732R
55/64	21.83	152	86	1/2			9LI5564R
7/8	22.23	152	86	1/2			9LI78R
29/32	23.02	152	86	1/2			9LI2932R
15/16	23.81	152	86	1/2			9LI1516R
31/32	24.61	152	86	1/2			9LI3132R
1	25.40	152	86	1/2			9LI1R
1 1/16	26.99	152	86	1/2			9LI1-116R
1 1/8	28.56	152	86	1/2			9LI1-18R
1 3/16	30.16	152	86	1/2			9LI1-316R
1 1/4	31.75	152	86	1/2			9LI1-14R



Sizes: 13/32" – 1/2"
Gold Series

- 135° split point cuts faster and reduces wandering
- TiN coating, reduces heat and increases lubricity for extended life
- Fully ground M2 HSS

**30%
MORE
HOLES**

BULK - 1 PCE

Supplied in hangable plastic pack

CARDED - 1 PCE

Supplied in hangable card



Sizes: 33/64" – 1 1/4"

- 118° split point, ideal for drilling into pilot holes
- Black oxide coating maximises lubricant hold, therefore assisting chip flow and heat dissipation
- 3 flats on shank, prevents slippage in chuck

**HEAVY
DUTY**

Full length ground from a single piece of HSS, eliminating breakage

CARDED - 1 PCE

Supplied in hangable card

Drill Sets – Metric

TUFFBOX™

Jobber Drill Sets – Metric

- Tough plastic case
- Rugged rubber grips
- Strong locking catch
- Supplied with security tab to stop pilfering
- Includes feeds and speeds chart



25 PCE
TUFFBOX Drill Set
Straight Shank







19 PCE
TUFFBOX Drill Set
Straight Shank



25 PCE
TUFFBOX Drill Set
Straight and
Reduced Shank

METRIC TUFFBOX™ SETS

No. of Pieces	Set Contents	Shank				
			GOLD	SILVER	BLACK	COBALT
19 PCE	Sizes: 1.0 – 10.0mm in 0.5 mm increments	Straight	SM19PB	SM19PBS	SM19PBB	SM19CO
25 PCE	Sizes: 1.0 – 13.0mm in 0.5 mm increments	Straight	SM25PB	SM25PBS	SM25PBB	SM25CO
25 PCE	Sizes: 1.0 – 13.0mm in 0.5 mm increments	Straight: 1.0 – 10.0mm Reduced: 10.5 – 13.0mm	SM25RPB			

TUFFBOX™

Jobber Drill Sets – Imperial

- Tough plastic case
- Rugged rubber grips
- Strong locking catch
- Supplied with security tab to stop pilfering
- Includes feeds and speeds chart







29 PCE
TUFFBOX Drill Set
Straight Shank



21 PCE
TUFFBOX Drill Set
Straight Shank



29 PCE
TUFFBOX Drill Set
Straight and
Reduced Shank

IMPERIAL TUFFBOX™ SETS						
No. of Pieces	Set Contents	Shank	GOLD	SILVER	BLACK	COBALT
21 PCE	Sizes: 1/16" - 3/8" in 1/64" increments	Straight	SI21PB	SI21PBS	SI21PBB	
29 PCE	Sizes: 1/16" - 1/2" in 1/64" increments	Straight	SI29PB	SI29PBS	SI29PBB	SI29CO
29 PCE	Sizes: 1/16" - 1/2" in 1/64" increments	Straight: 1/16" - 25/64" Reduced: 13/32" - 1/2"	SI29RPB			

Slim Box™

Jobber Drill Sets – Metric

- Strong metal box
- Slim and compact
- Security hang tab
- Feeds and speeds chart inside every drill set



25 PCE
Slim Box Drill Set
Straight Shank



19 PCE
Slim Box Drill Set
Straight Shank



25 PCE
Slim Box Drill Set
Straight and
Reduced Shank

METRIC SLIMBOX™ SETS			
No. of Pieces	Set Contents	Shank	GOLD
19 PCE	Sizes: 1.0 – 10.0mm in 0.5 mm increments	Straight	SM19
25 PCE	Sizes: 1.0 – 13.0mm in 0.5 mm increments	Straight	SM25
25 PCE	Sizes: 1.0 – 13.0mm in 0.5 mm increments	Straight: 1.0 – 10.0mm Reduced: 10.5 – 13.0mm	SM25R

Slim Box™

Jobber Drill Sets – Imperial

- Strong metal box
- Slim and compact
- Security hang tab
- Feeds and speeds chart inside every drill set



29 PCE
Slim Box Drill Set
Straight Shank



21 PCE
Slim Box Drill Set
Straight Shank



29 PCE
Slim Box Drill Set
Straight and
Reduced Shank

IMPERIAL SLIMBOX™ SETS			
No. of Pieces	Set Contents	Shank	GOLD
21 PCE	Sizes: 1/16" – 3/8" in 1/64" increments	Straight	SI21
29 PCE	Sizes: 1/16" – 1/2" in 1/64" increments	Straight	SI29
29 PCE	Sizes: 1/16" – 1/2" in 1/64" increments	Straight: 1/16" – 25/64" Reduced: 13/32" – 1/2"	SI29R

85 PCE Drill Set – Metric Gold Series



Metal Case Drill Set
Sizes: 1.0 – 10.0mm in 0.5mm increments

SET CONTENTS

JOBBER DRILL BIT	QTY per size
1.0, 1.5, 2.0, 2.5, 3.0, 3.5, 4.0, 4.5, 5.0, 5.5, 6.0 & 6.5mm	5
7.0, 7.5, 8.0, 8.5 & 9.0mm	4
9.5mm	3
10.0mm	2

Code: SM85



13 PCE Drill Set – Metric GOLD Series

Metal Case Drill Set
Sizes: 1.5 – 6.5mm

Code: SM13*

*Also available in:

SILVER Series Code: SM13S

COBALT Series Code: SM13CO



13 PCE Drill Set – Imperial GOLD Series

Metal Case Drill Set
Sizes: 1/6" – 1/4"

Code: SH13*

*Also available in:

SILVER Series Code: SH13S



100 PCE Drill Set – Metric Gold Series

Sizes: 1.0 – 10.0mm in 0.1mm increments
plus 10.5, 10.8, 11.0, 11.5, 11.8, 12.0, 12.5, 12.8 & 13.0mm

Code: SM100

Reduced Shank Jobber Drill Sets – Metric

**HEAVY
DUTY**

Full length ground from a single piece of HSS, eliminating breakage

- Plastic durable box
- 118° split point, ideal for drilling into pilot holes
- Black oxide coating maximises lubricant hold, therefore assisting chip flow and heat dissipation
- 3 flats on shank, prevents slippage in chuck



5 PCE
Reduced Shank
Drill Set

8 PCE
Reduced Shank
Drill Set

METRIC REDUCED SHANK SETS

No. of Pieces	Set Contents	Reduced Shank	Code
5 PCE	Sizes: 14, 16, 18, 22 & 25mm	12.7mm	RSM5
8 PCE	Sizes: 14, 15, 16, 16.5, 18, 20, 22 & 25mm	12.7mm	RSM8

Reduced Shank Jobber Drill Sets – Imperial

**HEAVY
DUTY**

Full length ground from a single piece of HSS, eliminating breakage

- Plastic durable box
- 118° split point, ideal for drilling into pilot holes
- Black oxide coating maximises lubricant hold, therefore assisting chip flow and heat dissipation
- 3 flats on shank, prevents slippage in chuck



5 PCE
Reduced Shank
Drill Set

8 PCE
Reduced Shank
Drill Set

IMPERIAL REDUCED SHANK SETS

No. of Pieces	Set Contents	Reduced Shank	Code
5 PCE	Sizes: 9/16", 5/8", 3/4", 7/8" & 1"	1/2" (12.7mm)	RS15
8 PCE	Sizes: 9/16", 5/8", 11/16", 3/4", 13/16", 7/8", 15/16" & 1"	1/2" (12.7mm)	RS18

BRISTOL

tool works



- Quality presentation
- Bold colouring
- Attractive packaging

Jobber Drill Sets Metric & Imperial

Quality products for the
discerning tradesman or handyman



Drills steel, wood and plastic



135° split point cuts faster
and reduces wandering



Available in:
Metric 13 PCE
Imperial 13 PCE



Counter displays
available in:
Metric 13 PCE
Imperial 13 PCE
20 per display



Available in:
Metric 25 PCE
Imperial 29 PCE



Counter displays
available in:
Metric 25 PCE
Imperial 29 PCE
5 per display

IMPERIAL & METRIC BRISTOL SETS

No. of Pieces	Set Type	Set Contents	Shank	Counter Display QTY	Code
13 PCE	METRIC	Sizes: 1.5, 2.0, 2.5, 3.0, 3.3, 3.5, 4.0, 4.2, 4.5, 5.0, 5.5, 6.0 & 6.5mm	Straight	20 sets per counter display (sold in complete displays only)	BTW13M
	IMPERIAL	Sizes: 1/16", 5/64", 3/32", 7/64", 1/8", 9/64", 5/32", 11/64", 3/16", 13/64", 7/32", 15/64" & 1/4"	Straight	20 sets per counter display (sold in complete displays only)	BTW13I
25 PCE	METRIC	Sizes: 1.0 - 13.0mm in 0.5mm increments	Straight	5 sets per counter display	BTW25M
29 PCE	IMPERIAL	Sizes: 1/16" - 1/2" in 1/64" increments	Straight	5 sets per counter display	BTW29I

Long Series Drills

Longer flute and overall length for drilling deeper holes

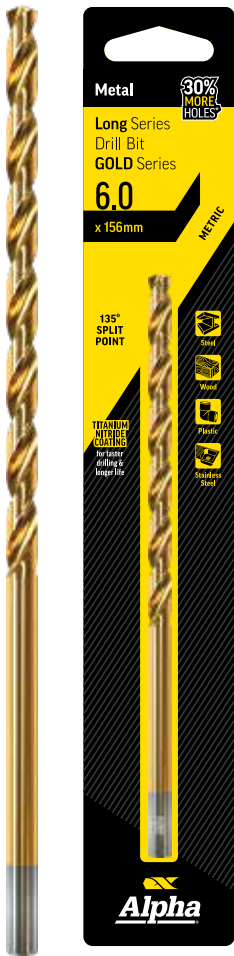

CARDED METRIC				
Ø mm	OAL mm	FL mm	GOLD	
				Carded
				1 PCE
2.0	95	62	9ELM020	
2.5	95	62	9ELM025	
3.0	130	76	9ELM030	
3.3	104	69	9ELM033	
3.5	137	76	9ELM035	
3.8	119	78	9ELM038	
4.0	146	86	9ELM040	
4.5	146	86	9ELM045	
5.0	152	92	9ELM050	
5.5	152	92	9ELM055	
6.0	156	95	9ELM060	
6.5	159	98	9ELM065	
7.0	159	98	9ELM070	
7.5	162	102	9ELM075	
8.0	165	105	9ELM080	
8.5	165	105	9ELM085	
9.0	171	108	9ELM090	
9.5	171	108	9ELM095	
10.0	178	111	9ELM100	
10.5	184	117	9ELM105	
11.0	184	117	9ELM110	
11.5	184	117	9ELM115	
12.0	201	125	9ELM120	
12.5	201	125	9ELM125	
13.0	203	121	9ELM130	

CARDED IMPERIAL				
Ø inches	Ø mm	OAL mm	FL mm	GOLD
				Carded
				1 PCE
5/64	1.98	95.5	51	9ELI564
3/32	2.38	108	57	9ELI332
7/64	2.78	118	64	9ELI764
1/8	3.17	131	70	9ELI18
9/64	3.57	137	76	9ELI964
5/32	3.97	137	76	9ELI532
11/64	4.37	146	86	9ELI1164
3/16	4.76	147	87	9ELI316
13/64	5.16	152	92	9ELI1364
7/32	5.56	152	92	9ELI732
15/64	5.95	158	97	9ELI1564
1/4	6.35	158	97	9ELI14
17/64	6.75	159	98	9ELI1764
9/32	7.14	159	98	9ELI932
19/64	7.54	162	102	9ELI1964
5/16	7.94	162	102	9ELI516
21/64	8.33	165	109	9ELI2164
11/32	8.73	175	115	9ELI1132
23/64	9.13	175	115	9ELI2364
3/8	9.53	174	111	9ELI38
13/32	10.32	184	121	9ELI1332
7/16	11.11	181	116	9ELI716
15/32	11.91	194	125	9ELI1532
1/2	12.7	201	125	9ELI12

CARDED - 1 PCE
Supplied in
hangable card

CARDED GAUGE				
Ø	Ø mm	OAL mm	FL mm	GOLD
				Carded
				1 PCE
#30	3.26	130	69	9ELG30

Extra Long Drills

Extra long flute and overall length for drilling extra deep holes

CARDED

METRIC

ø mm	OAL mm	FL mm	GOLD
			Carded 1 PCE
2.0	315	247	9EXLM020
3.0	315	247	9EXLM030
3.3	315	247	9EXLM033
4.0	315	247	9EXLM040
5.0	315	247	9EXLM050
6.0	315	247	9EXLM060
6.5	315	247	9EXLM065
8.0	315	247	9EXLM080
9.0	315	247	9EXLM090
10.0	315	247	9EXLM100
11.0	315	247	9EXLM110
11.5	315	247	9EXLM115
12.0	315	247	9EXLM120
12.5	315	247	9EXLM125
13.0	315	247	9EXLM130



CARDED – 1 PCE
Supplied in hangable card





Single
& Double End
Panel Drills



Single End Panel Drills



BULK

IMPERIAL & GAUGE						
Ø	Ø mm	OAL mm	FL mm	For Rivet	GOLD	BLACK
					Bulk 10 PACK	Bulk 10 PACK
1/8"	3.17	51	13	3mm & 1/8"	9SP18	9SP18B
# 30	3.26	51	13	1/8"	9SP30	9SP30B
# 20	4.09	60	16	4mm & 5/32"	9SP20	9SP20B
# 11	4.85	60	16	3/16"	9SP11	9SP11B

BULK - 10 PACK
Supplied in hangable plastic pack



Double End Panel Drills





BULK

IMPERIAL & GAUGE								
Ø	Ø mm	OAL mm	FL mm	For Rivet	GOLD	SILVER	BLACK	COBALT
					Bulk 10 PACK	Bulk 10 PACK	Bulk 10 PACK	Bulk 10 PACK
1/8"	3.17	51	13	3mm & 1/8"	9D18	9D18S		9D18CO
# 30	3.26	51	13	1/8"	9D30	9D30S	9D30B	9D30CO
# 20	4.09	60	16	4mm & 5/32"	9D20	9D20S	9D20B	9D20CO
# 11	4.85	60	16	3/16"	9D11	9D11S	9D11B	9D11CO

BULK - 10 PACK
Supplied in hangable plastic pack



CARDED

IMPERIAL & GAUGE							
Ø	Ø mm	OAL mm	FL mm	For Rivet	GOLD		SILVER
					Carded 2 PCE	Trade Pack* 10 PACK	Carded 2 PCE
1/8"	3.17	51	13	3mm & 1/8"	C9D18		
# 30	3.26	51	13	1/8"	C9D30	C9D30TP	C9D30S
# 20	4.09	60	16	4mm & 5/32"	C9D20	C9D20TP	C9D20S
# 11	4.85	60	16	3/16"	C9D11	C9D11TP	C9D11S

*New trade packs pending

CARDED - 2 PCE
Supplied in hangable card
CARDED - TRADE 10 PACK
Supplied in hangable card



Stub Drills

Stub Drills



BULK

METRIC

Ø mm	OAL mm	FL mm	Pack QTY	GOLD
2.0	38	11	10	9SM020
2.25	40	12	10	9SM0225
2.5	43	14	10	9SM025
2.75	45	17	10	9SM0275
3.0	48	22	10	9SM030
3.5	49	24	10	9SM035
4.0	54	27	10	9SM040
4.5	58	27	10	9SM045
4.9	61	26	10	9SM049
5.0	62	27	10	9SM050
5.1	62	27	10	9SM051
5.5	66	28	10	9SM055*
6.0	66	28	10	9SM060
6.1	70	31	10	9SM061
6.5	70	31	10	9SM065
7.0	74	34	5	9SM070
7.5	74	34	5	9SM075
8.0	79	37	5	9SM080
8.5	79	37	5	9SM085
9.0	84	40	5	9SM090
9.5	84	40	5	9SM095
10.0	89	43	1	9SM100
10.5	89	43	1	9SM105
11.0	95	47	1	9SM110
11.5	95	47	1	9SM115
12.0	102	51	1	9SM120
12.5	102	51	1	9SM125
13.0	102	51	1	9SM130

*5.5mm also available in COBALT Series (code: 9SM055COS)

BULK

IMPERIAL

Ø inches	Ø mm	OAL mm	FL mm	Pack QTY	GOLD	SILVER
5/64	1.98	43	18	10	9SI564	
3/32	2.38	44	19	10	9SI332	
7/64	2.78	48	22	10	9SI764	
1/8	3.17	48	22	10	9SI18	9SI18S
9/64	3.57	54	27	10	9SI964	
5/32	3.97	50	25	10	9SI532	
11/64	4.37	50	25	10	9SI1164	
3/16	4.76	54	27	10	9SI316	9SI316S
13/64	5.16	60	32	10	9SI1364	
7/32	5.56	57	30	10	9SI732	
15/64	5.95	62	33	10	9SI1564	
1/4	6.35	64	34	10	9SI14*	9SI14S*
17/64	6.75	67	37	10	9SI1764	
9/32	7.14	68	38	5	9SI932	
5/16	7.94	71	41	5	9SI516	9SI516S
11/32	8.73	75	43	5	9SI1132	
3/8	9.53	79	46	5	9SI38	9SI38S
13/32	10.32	84	49	1	9SI1332	9SI1332S
7/16	11.11	87	52	1	9SI716	
15/32	11.91	92	54	1	9SI1532	
1/2	12.70	95	57	1	9SI12	9SI12S

*1/4" also available in BLACK Series (code: 9SI14B)

1 PCE
 Sizes 10.0 - 13.0mm
 Sizes 13/32" - 1/2"



5 PACK
 Sizes 7.0 - 9.5mm
 Sizes 9/32" - 3/8"

10 PACK
 Sizes 2.0 - 6.5mm
 Sizes 5/64" - 17/64"

BULK
 Supplied in hangable
 plastic pack

Stub Drills



BULK GAUGE								
Ø	Ø mm	OAL mm	FL mm	For Rivet	GOLD	SILVER	BLACK	COBALT
					Bulk 10 PACK	Bulk 10 PACK	Bulk 10 PACK	Bulk 10 PACK
# 30	3.26	51	25	1/8"	9S30	9S30S	9S30B	
# 20	4.09	54	27	4mm & 5/32"	9S20	9S20S	9S20B	
# 19	4.22	57	29		9SG19			9SG19COS
# 11	4.85	58	30	3/16"	9S11	9S11S	9S11B	
# 10	4.92	57	27					9SG10COS

BULK - 10 PACK
Supplied in hangable plastic pack



CARDED GAUGE						
Ø	Ø mm	OAL mm	FL mm	For Rivet	GOLD	SILVER
					Carded 2 PCE	Carded 2 PCE
# 30	3.26	51	25	1/8"	C9S30	C9S30S
# 20	4.09	54	27	4mm & 5/32"	C9S20	C9S20S
# 11	4.85	58	30	3/16"	C9S11	C9S11S

CARDED - 2 PCE
Supplied in hangable card



HSS Morse Taper Shank Drills



118° split point, ideal for drilling into pilot holes

- Black oxide coating maximises lubricant hold, assisting chip flow and heat dissipation
- Premium HSS

BULK - 1 PCE
Supplied in plastic pack

BULK METRIC

Ø mm	Morse Taper	FL mm	BULK 1 PCE
5.0	MT1	52	9TSM050
6.0	MT1	55	9TSM060
7.0	MT1	70	9TSM070
8.0	MT1	75	9TSM080
9.0	MT1	80	9TSM090
10.0	MT1	94	9TSM100
11.0	MT1	94	9TSM110
12.0	MT1	101	9TSM120
13.0	MT1	101	9TSM130
14.0	MT1	108	9TSM140
15.0	MT2	114	9TSM150
16.0	MT2	120	9TSM160
17.0	MT2	125	9TSM170
18.0	MT2	130	9TSM180
19.0	MT2	135	9TSM190
20.0	MT2	140	9TSM200
21.0	MT2	145	9TSM210
22.0	MT2	150	9TSM220
23.0	MT2	155	9TSM230
24.0	MT3	160	9TSM240
25.0	MT3	160	9TSM250
27.0	MT3	170	9TSM270
28.0	MT3	170	9TSM280
29.0	MT3	175	9TSM290
30.0	MT3	175	9TSM300
31.0	MT3	180	9TSM310
32.0	MT4	185	9TSM320
33.0	MT4	185	9TSM330
34.0	MT4	190	9TSM340
35.0	MT4	190	9TSM350
36.0	MT4	195	9TSM360
37.0	MT4	195	9TSM370
38.0	MT4	200	9TSM380
39.0	MT4	200	9TSM390
40.0	MT4	200	9TSM400
41.0	MT4	205	9TSM410
42.0	MT4	205	9TSM420
43.0	MT4	210	9TSM430
44.0	MT4	210	9TSM440
45.0	MT4	210	9TSM450
46.0	MT4	215	9TSM460
47.0	MT4	215	9TSM470
48.0	MT4	220	9TSM480
49.0	MT4	220	9TSM490
50.0	MT4	220	9TSM500

Adaptor Sleeve for Morse Taper Shank

Morse Taper drill sleeves are used as reduction sizing for morse taper tooling



BULK

Size	MT# External	MT# Internal	BULK 1 PCE
MT2 - MT1	MT2	MT1	9TSM A2-1
MT3 - MT1	MT3	MT1	9TSM A3-1
MT3 - MT2	MT3	MT2	9TSM A3-2
MT4 - MT2	MT4	MT2	9TSM A4-2
MT4 - MT3	MT4	MT3	9TSM A4-3
MT5 - MT4	MT5	MT4	9TSM A5-4

- DIN 2185 precision manufactured
- Fully hardened and ground internally and externally to give maximum surface contact
- Used for drills, reamers and lathe centre shanks

BULK - 1 PCE
Supplied in
plastic pack

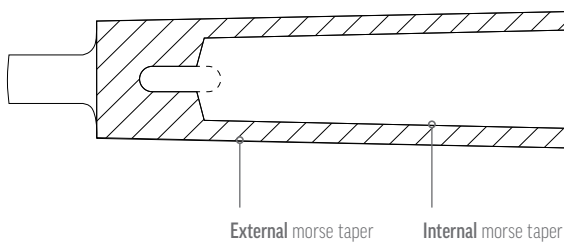



8mm
NON-SLIP
SHANK



Sheet
Metal



Steel



Plastic

2 FLUTE - Straight

for smooth cutting



8mm
NON-SLIP
SHANK



Sheet
Metal



Steel



Plastic

2 FLUTE - Spiral

Reduced vibration for fast,
clean and accurate holes



DRILLS AND DEBURRS in one process

- **Self-starting split point** removes the need for a pilot hole
 - **TiN coating reduces** heat and increases lubricity for extended life
 - Laser etched hole
 - **Premium HSS M2** raw material for extended life
- SUITS:** Non-hammer action portable power drills

Sheet
Metal

Steel



Plastic

4 FLUTE - Spiral

Cuts faster with less vibration for fast,
clean and accurate holes

Step Drills

Alpha is excited to present an extended range of high-quality step drills. Featuring Alpha Gold Series' signature superior quality construction, this step drill range is long lasting and efficient, and now includes a 4 flute spiral quick release step drill.

Step Drills – 2 Flute – Straight

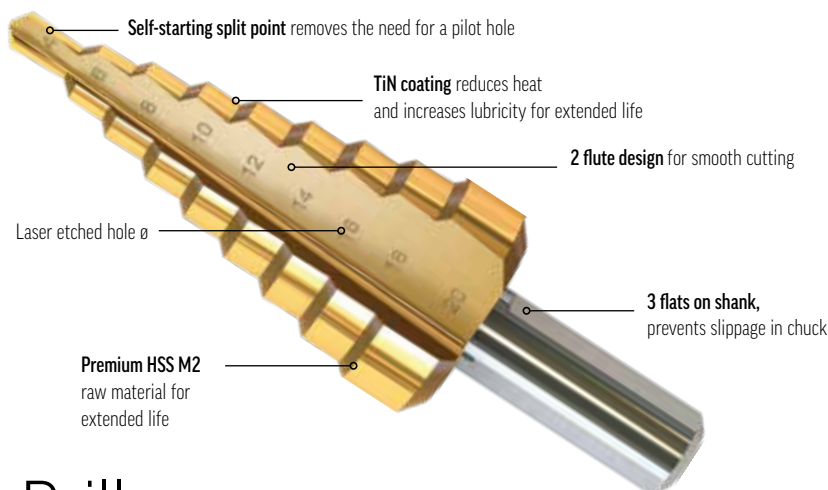

Step Drills 2 Flute – Straight



NON-SLIP SHANK



Sheet Metal



Steel



Plastic

BULK & CARDED

METRIC & IMPERIAL



CARDED – 1 PCE
Supplied in hangable or free-standing card

BULK – 1 PCE
Supplied in hangable plastic pack

ø	No. of Steps	ø Included	Shank ø mm	BULK 1 PCE	CARDED 1 PCE
4 – 12mm	9	4, 5, 6, 7, 8, 9, 10, 11 & 12mm	6.0	9STM4-12	C9STM4-12
4 – 20mm	9	4, 6, 8, 10, 12, 14, 16, 18 & 20mm	8.0	9STM4-20	C9STM4-20
5 – 35mm	13	5, 7.5, 10, 13, 16, 19, 21, 23, 26, 29, 31, 33 & 35mm	10.0	9STM5-35	C9STM5-35
6 – 30mm	13	6, 8, 10, 12, 14, 16, 18, 20, 22, 24, 26, 28 & 30mm	10.0	9STM6-30	C9STM6-30
6 – 32mm	14	6, 8, 10, 12, 14, 16, 18, 20, 22, 24, 26, 28, 30 & 32mm	10.0	9STM6-32	C9STM6-32
6 – 36mm	11	6, 9, 12, 15, 18, 21, 24, 27, 30, 33 & 36mm	10.0	9STM6-36	C9STM6-36
6 – 39mm	12	6, 9, 12, 15, 18, 21, 24, 27, 30, 33, 36 & 39mm	10.0	9STM6-39	C9STM6-39
1/4" – 3/4"	9	1/4", 5/16", 3/8", 7/16", 1/2", 9/16", 5/8", 11/16" & 3/4"	9.5	9STI14-34	C9STI14-34

Ideal for: Non-ferrous metals, sheet metal, plastic and stainless steel up to 3mm thick.

Suits: Non-hammer action portable power drills.



METRIC – 3 PCE 2 Flute – Straight Step Drill Set

CONTAINS 3 sizes:

- 4 – 12mm
- 4 – 20mm
- 6 – 30mm

Robust metal case

Code: STPSET3

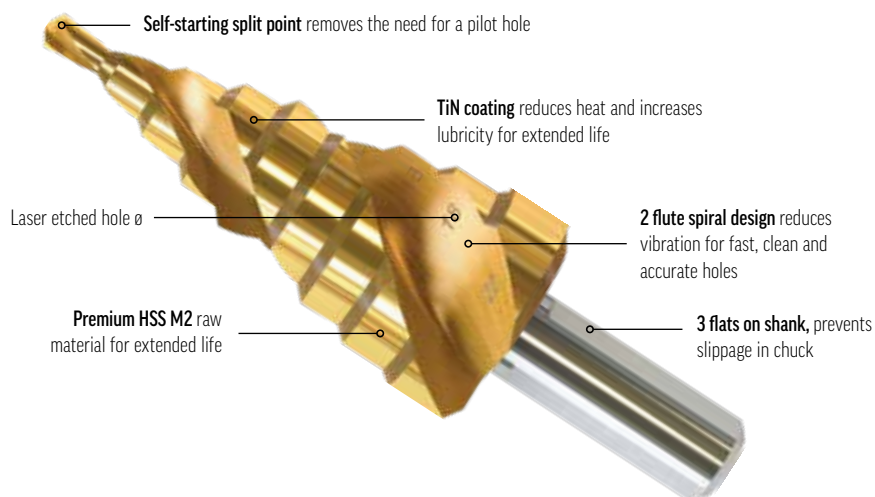

Step Drills 2 Flute – Spiral



BULK & CARDED

METRIC					
ø	No. of Steps	ø mm Included	Shank ø mm	BULK 1 PCE	CARDED 1 PCE
4 – 12mm	9	4, 5, 6, 7, 8, 9, 10, 11 & 12mm	6.0	9STSFM4-12S	C9STSFM4-12S
4 – 20mm	9	4, 6, 8, 10, 12, 14, 16, 18, 20mm	8.0	9STSFM4-20S	C9STSFM4-20S
6 – 30mm	13	6, 8, 10, 12, 14, 16, 18, 20, 22, 24, 26, 28 & 30mm	10.0	9STSFM6-30S	C9STSFM6-30S
6 – 36mm	11	6, 9, 12, 15, 18, 21, 24, 27, 30, 33 & 36mm	10.0	9STSFM6-36S	C9STSFM6-36S



CARDED - 1 PCE
Supplied in hangable or free-standing card

BULK - 1 PCE
Supplied in hangable plastic pack

Ideal for: Non-ferrous metals, sheet metal, plastic and stainless steel up to 3mm thick.

Suits: Portable and fixed pedestal drilling machines.

Step Drills - 4 Flute - Spiral

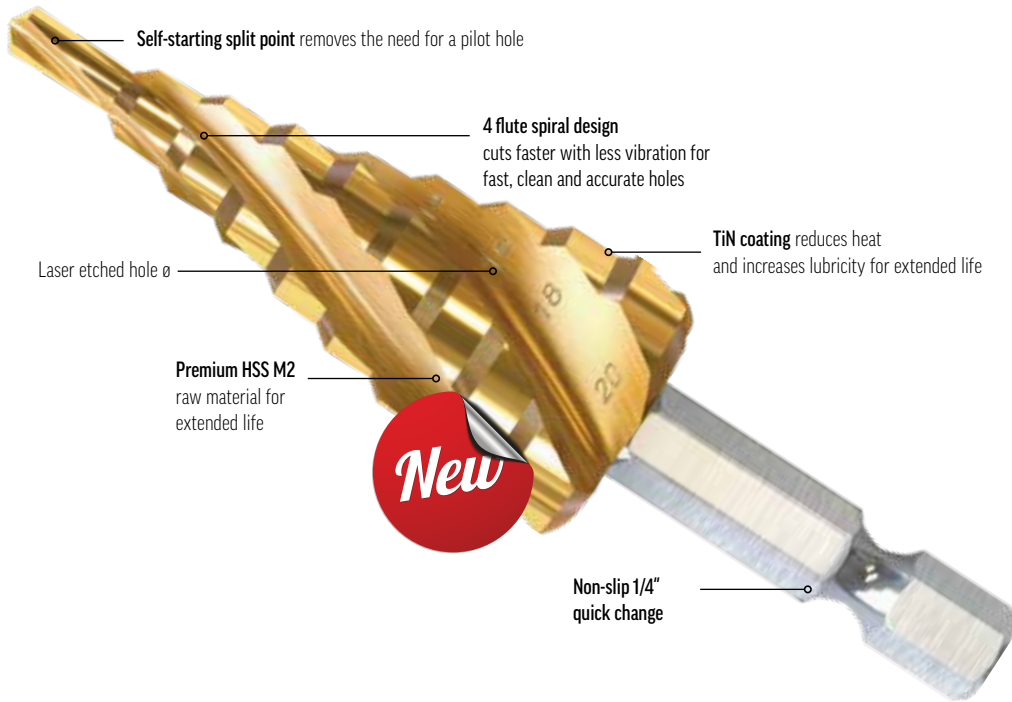

4 Flute - Spiral



1/4" QUICK CHANGE



Ideal for cordless drills

CARDED

METRIC & IMPERIAL - QUICK RELEASE

ø	No. of Steps	ø Included	Shank ø inch	CARDED 1 PCE
4 - 12mm	9	4, 5, 6, 7, 8, 9, 10, 11 & 12mm	1/4	C9STSFM4-12QR
4 - 20mm	9	4, 6, 8, 10, 12, 14, 16, 18 & 20mm	1/4	C9STSFM4-20QR
6 - 30mm	13	6, 8, 10, 12, 14, 16, 18, 20, 22, 24, 26, 28 & 30mm	1/4	C9STSFM6-30QR
6 - 32mm	14	6, 8, 10, 12, 14, 16, 18, 20, 22, 24, 26, 28, 30 & 32mm	1/4	C9STSFM6-32QR
1/4" - 3/4"	9	1/4", 5/16", 3/8", 7/16", 1/2", 9/16", 5/8", 11/16" & 3/4"	1/4	C9STSF14-34QR

Ideal for: Non-ferrous metals, sheet metal, plastic and stainless steel up to 3mm thick.

Suits: Cordless drills.



CARDED - 1 PCE

Supplied in hangable or free-standing card



12 SKUS
19 items

Core Range Merchandiser

Size (mm): 594 W x 565 H

Code: **STD-FL**

DESCRIPTION	SIZE	CODE	QTY
2 Flute - Straight	4 - 12mm	C9STM4-12	2
	4 - 20mm	C9STM4-20	2
	5 - 35mm	C9STM5-35	1
	6 - 30mm	C9STM6-30	2
	6 - 36mm	C9STM6-36	1
	6 - 39mm	C9STM6-39	1
4 Flute - Spiral	4 - 12mm	C9STFM4-12QR	2
	4 - 20mm	C9STFM4-20QR	2
	6 - 30mm	C9STFM6-30QR	2
	6 - 32mm	C9STFM6-32QR	1
	1/4 - 3/4"	C9STSF114-34QR	2
2 Flute - Spiral	6 - 36mm	C9STFM6-36S	1

HSS COBALT Spot Weld Drills



For drilling out spot welded panels
• 1 flat on shank for spot weld drill

BULK

METRIC

Ø mm	OAL mm	FL mm	BULK 1 PCE
6.5	46	17	9S65
8.0	46	18	9S80
8.0	76	18	9L80

HSS COBALT TiN COATING Spot Weld Drills



For drilling out spot welded panels
• 1 flat on shank for spot weld drill

BULK

METRIC

Ø mm	OAL mm	FL mm	BULK 1 PCE
8.0	46	18	9S80T
8.0	76	18	9L80T
8.0	117	20	9XL80T

HSS COBALT DURA COATING Spot Weld Drills



For drilling out spot welded panels
• 1 flat on shank for spot weld drill

BULK

METRIC

Ø mm	OAL mm	FL mm	BULK 1 PCE
8.0	46	18	9S80DUR
8.0	76	18	9L80DUR



BULK - 1 PCE

All spot weld drills and centre drills supplied in hangable plastic packs

HSS Centre Drills



Ideal for creating accurate centre holes, spotting or starting a precise hole on the end of a round bar.

- Drills and chamfers in one process
- 60° stepped split point

BULK

GAUGE

Size No.	Ø inches	OAL mm	Flute length mm	Drill Ø mm	Shank Ø mm	BULK 1 PCE
#1	1/8	31.5	8.0	1.35	3.18	9CD1-18
#2	3/16	46.9	11.7	2.3	4.76	9CD2-316
#3	1/4	50.6	13.8	2.85	6.35	9CD3-14
#4	5/16	53.0	15.0	3.2	7.94	9CD4-516
#5	7/16	67.8	22.0	4.85	11.11	9CD5-716
#6	1/2	75.2	27.8	5.8	12.7	9CD6-12
#8	3/4	88.1	33.2	8.0	19.05	9CD8-34

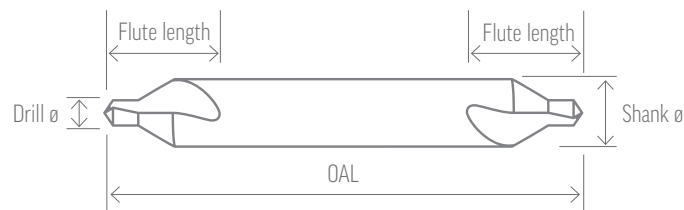

Left Hand Drills

For the removal of damaged bolts (stud) and screws



CARDED

IMPERIAL				COBALT	Suits Bolt Thread	
Ø inches	Ø mm	OAL mm	FL mm		Carded 1 PCE	Ø mm
5/64	1.98	43	18	9LI564COL	4.0 - 4.5	5/32 - 3/16
7/64	2.78	44	19	9LI764COL	5.5 - 6.5	7/32 - 1/4
5/32	3.97	50	25	9LI532COL	8.0	5/16
1/4	6.35	64	34	9LI14COL	10.0 - 12.0	3/8 - 1/2
19/64	7.54	107	81	9LI1964COL	14.0 - 20.0	9/16 - 3/4

CARDED
1 PCE
Supplied on
hangable card

How to use

1. If possible, grind or flatten the head of the damaged bolt or screw.
2. Use a heavy hammer and centre punch to mark the centre of the bolt or screw. This will prevent the drill wandering.
3. Drill into the bolt or screw in reverse using a small size left hand drill with a variable speed reversible drill.
4. If the bolt does not reverse out, use the small hole as a pilot hole and change to a larger size left hand drill. Most bolts come out before the hole drilling operation is finished.
5. The drill will grab the bolt when breaking through the backside. Typically, this is the stage when the broken fastener will spin out of the threaded hole. When drilling through the broken bolt, vibration will help to break the bolt free.

NOTE: If this drilling operation has not removed the broken stud or bolt, the hole drilled will form a pilot hole for a screw extractor.



HSS

Screw Extractors

- Reverse tapered cutting screw thread
- Square end for use with tapping handles



CARDED

		Suits Left Hand Drill		Suits Bolt Thread		
Ø mm	CARDED 1 PCE	Ø mm	Ø inches	Ø mm	Ø inches	
#1	3.47	9SE01	1.98	5/64	4.0 - 4.5	5/32 - 3/16
#2	4.80	9SE02	2.78	7/64	5.5 - 6.5	7/32 - 1/4
#3	6.35	9SE03	3.97	5/32	8.0	5/16
#4	8.33	9SE04	6.35	1/4	10.0 - 12.0	3/8 - 1/2
#5	11.31	9SE05	7.54	19/64	14.0 - 20.0	9/16 - 3/4

CARDED
1 PCE
Supplied on
hangable card

How to use

1. If possible, grind or flatten the head of the damaged bolt or screw.
2. With a heavy hammer and centre punch, mark the centre of the bolt or screw; this will prevent the pilot drill wandering.
3. The extractor requires a pilot hole, start with a small Alpha left handed drill bit (e.g. 5/64").
4. If required, drill the hole out larger. It is best to use a left hand drill for this step, as this may be enough to remove the stud without a screw extractor.
5. Select the correct size screw extractor for the hole. See table above.
6. With a tap wrench turn the screw extractor into the hole in an anti-clockwise direction. The reverse threads force the extractor into the hole until the broken bolt or stud is forced to turn. Continue turning until the stud is removed.

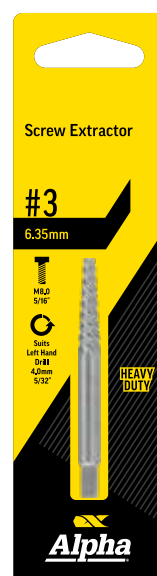

Hex Drill Bit

Ideal for general purpose drilling



135° split point cuts faster and reduces wandering

1/4" QUICK CHANGE



HSS
Hex Drill Bits

Fully ground M2 HSS



CARDED - 1 PCE
Supplied in hangable card

CARDED
METRIC

Drill ø mm	Drill ø inches	OAL mm	FL mm	CARDED 1 PCE
1.5	1/16	65	19	9QRM015
2.0	5/64	73	23	9QRM020
2.4	3/32	78	30	9QRM024
2.5	3/32	78	28	9QRM025
3.0	7/64	81	33	9QRM030
3.2	1/8	89	38	9QRM032
3.3	1/8	89	38	9QRM033
3.5	9/64	90	38	9QRM035
3.6	9/64	94	46	9QRM036
4.0	5/32	95	44	9QRM040
4.2	11/64	98	44	9QRM042
4.5	11/64	102	49	9QRM045
4.8	3/16	109	56	9QRM048
5.0	13/64	104	55	9QRM050
5.5	7/32	116	58	9QRM055
5.6	7/32	116	61	9QRM056
6.0	15/64	113	56	9QRM060
6.3	1/4	123	68	9QRM063
6.5	1/4	124	65	9QRM065



15 PCE
Hex Shank Drill Set

Contains:

13 x Hex drill bits: 1.5, 2.0, 2.5, 3.0, 3.3, 3.5, 4.0, 4.2, 4.5, 5.0, 5.5, 6.0, 6.5

1 x Quick release bit holder

1 x Insert bit: PH2

Code: 9QRM-SET15

Box QTY: 6



Ideal for impact drivers



Hex Drill Changeable



135° split point cuts faster and reduces wandering

Ideal for the widest range of materials



TITANIUM NITRIDE COATING
for faster drilling & longer life



Removable **GOLD Series** Drill for easy replacement
See page 10 to 15 for carded and bulk GOLD Series Drills

CARDED

METRIC		GOLD Carded 1 PCE
Drill ø mm	Drill ø inches	
1.0	1/32	TDS0100
1.6	1/16	TDS0160
2.0	5/64	TDS0200
2.4	3/32	TDS0240
2.8	7/64	TDS0280
3.0		TDS0300
3.2	1/8	TDS0320
3.5		TDS0350
3.6	9/64	TDS0360
4.0	5/32	TDS0400
4.4	11/64	TDS0440
5.0		TDS0500
5.2	13/64	TDS0520
5.6	7/32	TDS0560
6.0	15/64	TDS0600
6.35	1/4	TDS0630
7.0	9/32	TDS0700
8.0	5/16	TDS0800
9.5	3/8	TDS0950

CARDED - 1 PCE
Supplied in hangable card



CARDED

IMPERIAL		GOLD Carded 1 PCE
Drill ø inches	Drill ø mm	
1/8	3.20	TDS18
5/32	4.00	TDS532
3/16	4.76	TDS316
1/4	6.35	TDS14
3/8	9.525	TDS38

CARDED - 1 PCE
Supplied in hangable card

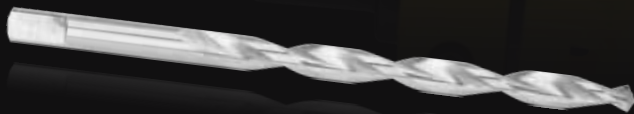

Countersinks



Countersinks	51
Deburrer Countersink	53
Sets	54
Stepped Drill Bits	55
TCT Drill & Countersink	56
HSS Drill & Countersink	57
Decking Drill & Countersinks	59



COUNTERSINK FEEDS & SPEEDS

To determine optimum speed, start at the lower end of the speed range, then increase the speed until performance is maximised. It is important not to operate at an excessive RPM as chattering may occur and the cutting area can overheat and become prematurely dull.

$$\text{Countersink RPM formula} = \frac{\text{Cutting Speed} \times 318.057}{\text{Diameter of cutter (mm)}}$$

For example, to cut aluminium with a 20.5mm 3 flute countersink

$$= \frac{45 \times 318.057}{20.5}$$

$$= 698 \text{ RPM}$$

MATERIAL	M/MIN.
Aluminium/Aluminium Alloys	45 – 75
Brass / Bronze (ordinary)	25 – 40
Magnesium/Magnesium Alloys	40 – 75
Iron – Cast (soft)	25 – 40
Iron – Cast (medium hard)	15 – 30
Iron – Hard Chilled	3 – 10
Iron – Malleable	25 – 30
Monel, High Nickel Steel	10 – 15
Steel – Mild (0.2 – 0.3 carbon)	25 – 30
Steel – Mild (0.4 – 0.5 carbon)	20 – 25
Tool Steels (1.2 carbon)	15 – 20
Steel – Forgings	10 – 15
Steel – Alloys (300 – 400 Brinnell)	5 – 10
Steel – High Tensile (35 – 40 Re)	10 – 15
Steel – High Tensile (40 – 45 Re)	8 – 15
Steel – High Tensile (45 – 50 Re)	5 – 10
Steel – High Tensile (50 – 55 Re)	2 – 5
Stainless Steel – Free Machining	10 – 25
Stainless Steel – Work Hardening	5 – 10
Plastics, Bakelite	30 – 75

COUNTERSINKING TROUBLE SHOOTING

PROBLEM	CAUSE	SOLUTION
Excessive cutting edge wear	Incorrect feeds and speeds	Increase feed - especially when machining ductile or free machining materials, also try reducing speed
	Rough cutting edge	Lightly hone cutting edge with fine grit diamond hone
	Insufficient coolant	Increase coolant flow - review type of coolant
Chipping	Poor chip removal	Use tool with larger flute space - larger diameter or fewer flutes reducing speed
	Re-cutting work hardened chips	Increase coolant flow
	Vibration	Increase rigidity of set-up, especially worn tool holders
Short tool life	Excessive cratering	Increase speed or decrease feed flutes reducing speed
	Abrasive material	Decrease speed and increase feed and/or increase coolant flow
	Hard materials	Reduce speed - rigidity very important
Glazed finish	Insufficient chip room	Use larger diameter tool
	Delayed resharpening	Prompt resharpening to original geometry will increase tool life
	Feed too light	Increase feed
Rough finish	Dull cutting edge	Resharpen tool to original geometry
	Insufficient clearance	Resharpen tool with more clearance
Chattering	Dull cutting edge	Resharpen to original tool geometry
	Wrong feeds and speeds	Increase speed - also try reducing feed
Chattering	Insufficient machine horsepower	Use tool with fewer flutes as correct feeds and speeds must be maintained
	Wrong feeds and speeds	Resharpen tool with more clearance

HSS COBALT
with
TiN
coating

3X LIFE GOLD Series

Designed for long-lasting results in the toughest materials



1/4" QUICK CHANGE

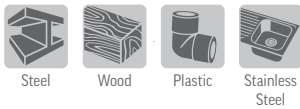

Suits: Non-hammer action portable power & pedestal drills

HSS COBALT TiN COATING 3 Flute 90° Countersink

- Fully ground M2 HSS-Co8 increases strength and countersink life
- Titanium nitride coating reduces heat and increases lubricity for extended life
- 3 flute design provides clean and fast countersinking and deburring with a cordless drill

CARDED

METRIC

Head ø mm	Head ø inches	OAL mm	Shank ø inches	Range min - max	CARDED 1 PCE
13	33/64	42.0	1/4	2 - 13	CS3-13QR
16	5/8	43.0	1/4	3 - 16	CS3-16QR
19	3/4	45.5	1/4	4 - 19	CS3-19QR

CARDED - 1 PCE
Supplied in hangable card

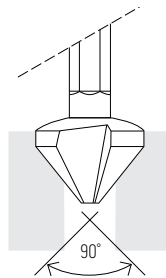
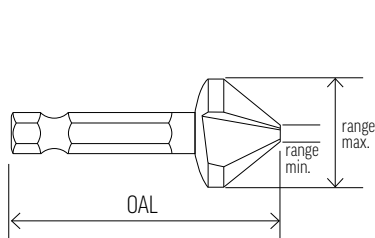

HSS COBALT 1 Flute 90° Countersink



- Simple to sharpen by grinding the face of the flute
- Fully ground M42 HSS-Co8 increases strength and countersink life

Single flute construction provides less aggressive and slower cutting than multi-flutes, therefore reducing the risk of chattering permitting optimum performance for the handyman and portable power tools

GENERAL PURPOSE countersinking and deburring in low density materials:		Fully ground HSS COBALT for increased strength & longer life	
Mild Steel	Aluminium	Softwood	Plastic
○ Mild Steel	✗ Cast Iron	● Softwood	
✗ Hard Steel	✗ Brass	○ Hardwood	
● Aluminium	✗ Stainless Steel	● Soft Plastic	
		○ Hard Plastic	
Legend: ● Optimal ○ Effective ✗ Not recommended			
■■■■■ Productivity speed ■■■■■ Power drill suitability ■■■■■ Machine use suitability			



BULK

METRIC

Head ø mm	Head ø inches	OAL mm	Shank ø mm	Range min - max	BULK 1 PCE
10.0	5/16	46.0	6	1 - 10	CS1-10
16.0	5/8	46.5	8	2 - 16	CS1-16
20.0	3/4	47.0	10	2 - 20	CS1-20
25.0	1	51.0	10	3 - 25	CS1-25
30.0	1 3/16	71.0	12	3 - 30	CS1-30

BULK - 1 PCE Supplied in hangable plastic pack

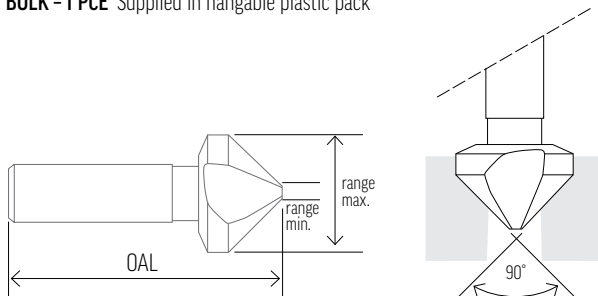

HSS COBALT 3 Flute 90° Countersink



- Fully ground M42 HSS-Co8 increases strength and countersink life

Three flute construction reduces chip load and controls chatter, which permits higher feed rates. Recommended machine use for accurate speed and feed rates for optimum results.

GENERAL PURPOSE countersinking and deburring in high density materials:		Fully ground HSS COBALT for increased strength & longer life	
Mild Steel	Aluminium	Hardwood	Plastic
● Mild Steel	✗ Cast Iron	○ Softwood	
✗ Hard Steel	✗ Brass	● Hardwood	
● Aluminium	✗ Stainless Steel	○ Soft Plastic	
		● Hard Plastic	
Legend: ● Optimal ○ Effective ✗ Not recommended			
■■■■■ Productivity speed ■■■■■ Power drill suitability ■■■■■ Machine use suitability			



BULK

METRIC

Head ø mm	Head ø inches	OAL mm	Shank ø mm	Range min - max	BULK 1 PCE
6.3	1/4	46	5	1 - 6.3	CS3-6.3
8.3	21/64	46	6	1 - 8.3	CS3-8.3
10.4	13/32	54	6	1 - 10.4	CS3-10.4
12.4	1/2	54	8	2 - 12.4	CS3-12.4
14.4	9/16	56	8	2 - 14.4	CS3-14.4
16.5	21/32	60	10	2 - 16.5	CS3-16.5
20.5	13/16	63	10	2 - 20.5	CS3-20.5
25.0	1	51	10	3 - 25.0	CS3-25
30.0	1 3/16	71	12	3 - 30.0	CS3-30
40.0	1 9/16	80	13	3 - 40.0	CS3-40

BULK - 1 PCE Supplied in hangable plastic pack

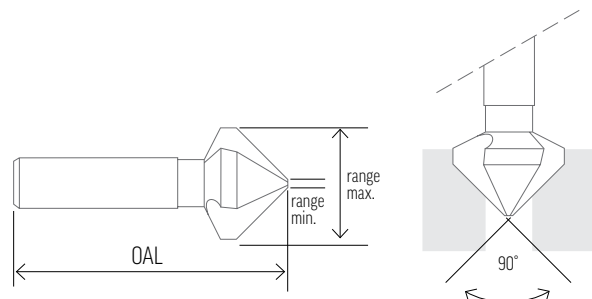

HSS AL 5 Flute 90° Countersink



• Fully ground HSS-AL increases strength and countersink life

Five flute construction provide optimum stability in hard materials for fast productivity with a fine finish. Perfect for stainless steel. Recommended machine use for accurate speed and feed rates for optimum results.

GENERAL PURPOSE countersinking and deburring:		Fully ground HSS AL for increased strength & longer life
Steel Stainless Steel Wood Plastic		
● Mild Steel ● Hard Steel ● Aluminium	● Cast Iron ● Stainless Steel	○ Softwood* ○ Hardwood* ○ Soft Plastic* ○ Hard Plastic*
Legend: ● Optimal ○ Effective ✘ Not recommended		
■■■■ Productivity speed ■■■■ Power drill suitability ■■■■ Machine use suitability	*Restrict speed to 85RPM for plastic and wood to avoid chattering	



BULK

METRIC					
Head ø mm	Head ø inches	OAL mm	Shank ø mm	Maximum capacity	BULK 1 PCE
8.0	5/16	35	5.00	8	CS5-8
12.0	1/2	39	6.35	12	CS5-12
16.0	5/8	52	8.00	16	CS5-16
20.0	3/4	58	10.00	20	CS5-20

BULK - 1 PCE Supplied in hangable plastic pack

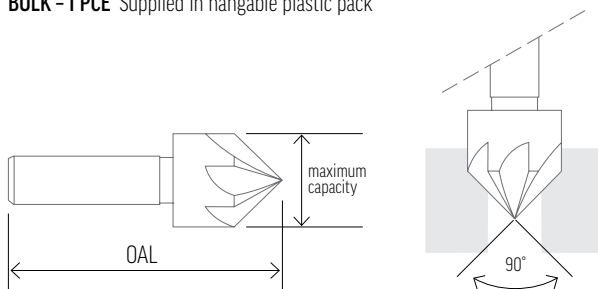

HSS COBALT Cross Hole 90° Deburrer Countersink



• Fully ground M42 HSS-Co8 increases strength and countersink life

The cross hole construction is the most universal product suiting the widest range of materials. Optimum deburrer results are obtained in ferrous and non-ferrous metals. Countersinking optimum results are obtained in softer materials such as wood or plastic, however fluted countersinks are more suited for countersinking hard metals.

GENERAL PURPOSE countersinking and deburring:		Fully ground HSS COBALT for increased strength & longer life
Steel Stainless Steel Wood Plastic		
Deburring: ● Mild Steel ● Hard Steel ● Aluminium	● Cast Iron ● Stainless Steel ● Brass	○ Softwood ○ Hardwood ○ Soft Plastic ○ Hard Plastic
Legend: ● Optimal ○ Effective ✘ Not recommended		
Countersinking: ✘ Mild Steel ✘ Hard Steel ● Aluminium	✘ Cast Iron ✘ Brass ✘ Stainless Steel	● Softwood ● Hardwood ● Soft Plastic ● Hard Plastic
Legend: ● Optimal ○ Effective ✘ Not recommended		
■■■■ Productivity speed ■■■■ Power drill suitability ■■■■ Machine use suitability		



BULK

METRIC					
Head ø mm	Head ø inches	OAL mm	Shank ø mm	Range min - max	BULK 1 PCE
10.0	5/16	46.0	6	4 - 9	CSCH-10
14.0	35/64	46.0	8	6 - 13	CSCH-14
21.5	27/32	64.5	10	8 - 19	CSCH-21
28.0	1 7/64	80.0	12	10 - 24	CSCH-28
35.0	1 3/8	97.0	15	12 - 32	CSCH-35
44.0	1 47/64	115.0	15	16 - 40	CSCH-44

BULK - 1 PCE Supplied in hangable plastic pack

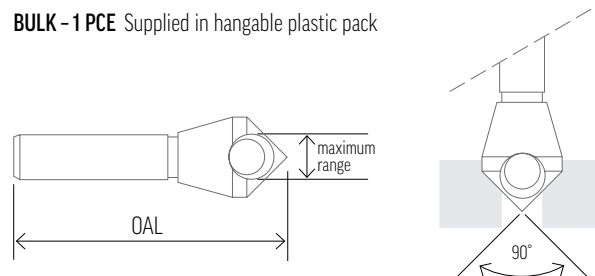

Sets



Fully ground
**HSS
 COBALT**
 for increased
 strength & longer life

6 PCE
**3 Flute 90°
 Countersink Set**

Metal Case Set
 Head \varnothing Sizes: 6.3, 8, 10, 12, 16 & 20mm

Code: CS3-SET6



Fully ground
**HSS
 COBALT**
 for increased
 strength & longer life

3 PCE
**Cross Hole 90°
 Deburrer
 Countersink Set**

Head \varnothing Sizes: 10, 14 & 21.5mm

Code: CSCH-SET3

HSS Stepped Drill Bits

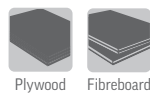

Drills precise stepped holes for director screws

Stepped drill bits are designed to pre-drill clearance holes through the first piece of material and pilot holes for the threads in the second piece of material.

CARDED

METRIC			Suits director screw
Drill ϕ mm	OAL mm	CARDED 1 PCE	
3.5 - 5.0	99	9SD050	5
4.8 - 7.0	108	9SD070	7

CARDED - 1 PCE
Supplied in hangable card

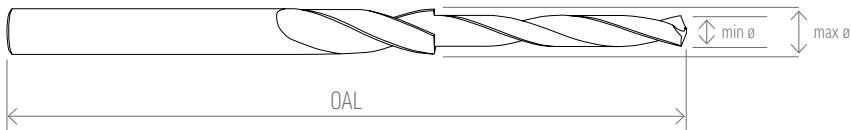

TCT

IDEAL FOR
TIMBER DECKING
& CEMENT SHEET



Wood



Cement Sheet



1/4"

QUICK
CHANGE

TCT Drill & Countersink

Ideal for timber decking and cement sheet

CARDED METRIC

Drill ø mm	Drill ø inches	Countersink ø mm	CARDED 1 PCE	Suits Screw Gauge
2.0		9.5	AS02004*	
2.4	3/32	10	AS02404	6G
2.8	7/64	10	AS02804	6G
3.0		10	AS03004	7G
3.2	1/8	11	AS03204	8G
3.5		11	AS03504	10G
4.0	5/32	11	AS04004	12G
4.8		11.5	AS04804*	12G
5.0	13/64	11	AS05004	12G
6.0	15/64	12	AS06004*	14G

Suits: Portable power drills

*Available while stocks last

CARDED - 1 PCE
Supplied in
hangable card

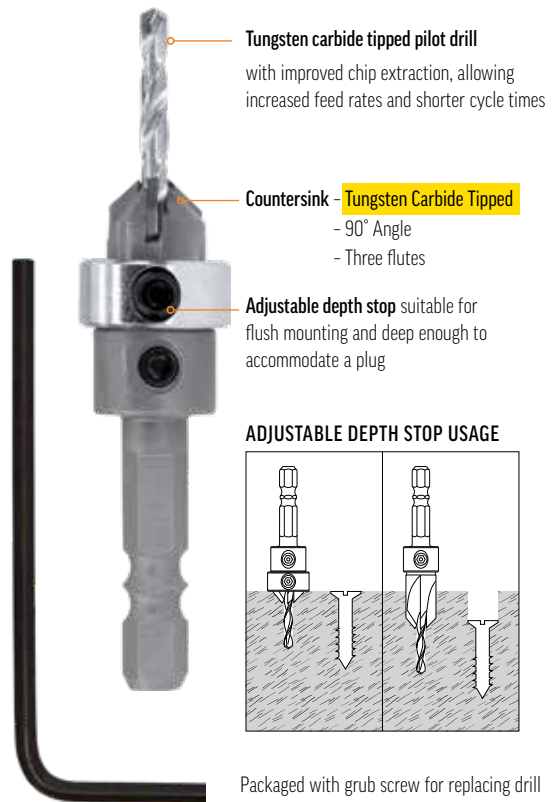

Packaged with grub screw for replacing drill and adjusting the depth stop

HSS Drill & Countersink

Ideal for timber decking, woodwork and steel



IDEAL FOR
TIMBER DECKING,
WOODWORK & STEEL



CARDED

METRIC				Suits Screw Gauge
Drill ø mm	Drill ø inches	Countersink ø mm	CARDED 1 PCE	
2.4	3/32	8	HS02404	6G
2.8	7/64	8	HS02804	6G
3.0		11	HS03004	7G
3.2	1/8	11	HS03204	8G
3.5		11	HS03504	10G
4.0	5/32	11	HS04004	12G

Suits: Portable power drills

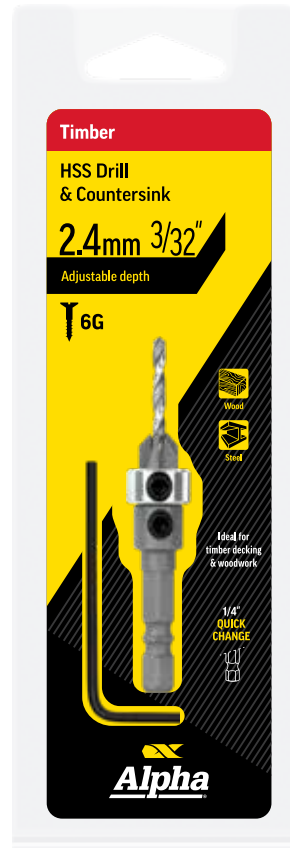
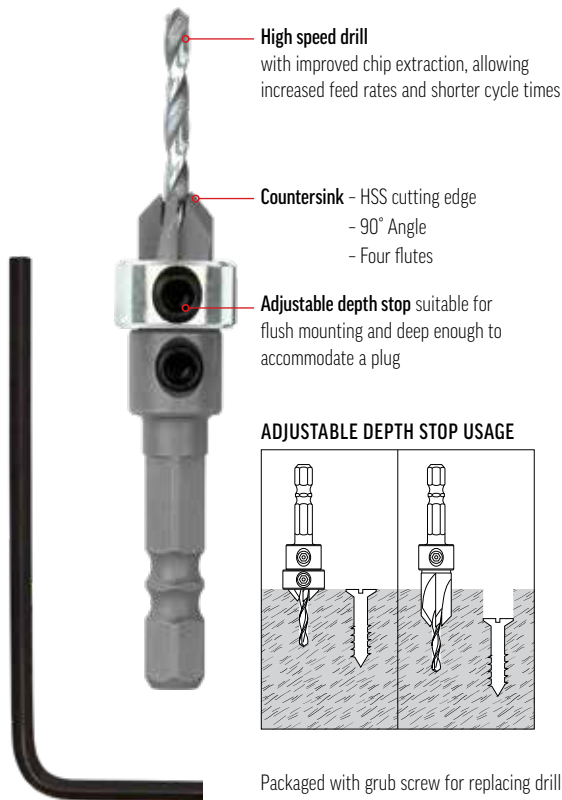

CARDED - 1 PCE
Supplied in
hangable card

TCT & CRV



NON MARKING
Tested on common hardwoods

SCRATCH FREE
rubber stop collar

Free-spinning stop collar with rubber o-ring protects the work surface from marks and scratches. When the collar stops spinning, the hole is complete

HEAVY DUTY
hardened and tempered for extended life

Anti-clog design improves visibility and debris removal

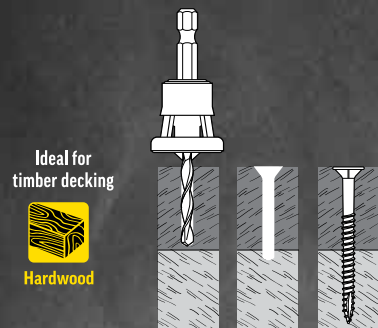

Ideal for timber decking
Hardwood

Professional Clean Finish
The ultimate all-in-one, single drilling and countersink tool for timber decking



Parabolic High Speed Steel (HSS) drill bit
with improved chip extraction, allows for increased feed rates and shorter cycle times

BONUS Replacement Bit

Adjustable countersink depth suitable for flush mounting and deep enough to accommodate a plug

1/4" QUICK CHANGE

Packaged with a hex key

Available in TCT or CRV



TCT Countersink
• Tungsten Carbide Tipped (TCT) countersink for clean cutting and 3 times life
• 2 flutes

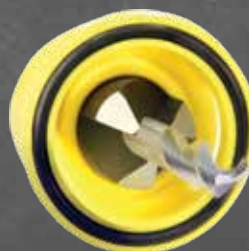

CRV Countersink
• Chrome Vanadium (CRV) countersink for clean cutting
• 3 flutes

TCT COUNTERSINK Decking Drill & Countersink



2 FLUTE
COUNTERSINK

Ideal for: Timber decking (hardwood and composite materials) and woodworking



CARDED

GAUGE						Suits flat head decking screws
#	Drill ø mm	Countersink ø mm	Countersink angle	Overall hole depth mm	CARDED 1 PCE	
#8	3.2	6.6	60°	30	ASD080	8G (4.5mm)
#10	3.6	9.2	90°	30	ASD100	10G (5.0mm)
#12	4.0	11.0	82°	40	ASD120	12G (5.5mm)
#14	5.25	12.9	82°	40	ASD140	14G (6.2mm)

CARDED - 1 PCE
Supplied in hangable card

CRV COUNTERSINK Decking Drill & Countersink



3 FLUTE
COUNTERSINK

Ideal for: Timber decking (hardwood and composite materials) and woodworking



CARDED

GAUGE						Suits flat head decking screws
#	Drill ø mm	Countersink ø mm	Countersink angle	Overall hole depth mm	CARDED 1 PCE	
#8	3.2	6.6	60°	30	HSD080	8G (4.5mm)
#10	3.6	9.2	90°	30	HSD100	10G (5.0mm)
#12	4.0	11.0	82°	40	HSD120	12G (5.5mm)
#14	5.25	12.9	82°	40	HSD140	14G (6.2mm)

CARDED - 1 PCE
Supplied in hangable card

HSS Parabolic Drills



Ideal for
Timber Decking



Parabolic High Speed Steel (HSS) drill bit with improved chip extraction, allows for increased feed rates and shorter cycle times when drilling in timber

CARDED

METRIC			Suits decking countersink
ø mm	OAL mm	CARDED 5 PACK	
3.2	46	DCRD0320-5	#8
3.6	46	DCRD0360-5	#10
4.0	60	DCRD0400-5	#12
5.25	60	DCRD052560-5	#14
	95*	DCRD052595-5	#14

CARDED
5 PACK
Supplied in hangable card



DRILL REPLACEMENT INSTRUCTIONS

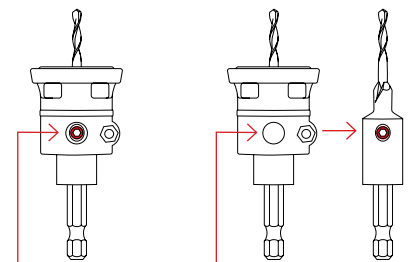

If hex screw is aligned with collar, simply loosen hex screw to replace the drill

If hex screw is not visible, remove the collar to gain access to the drill bit hex screw

*95mm OAL for long fasteners and special applications



Threading

CARBON

TAPS & DIES - BULK

Metric Coarse	62 & 63
Metric Fine	62 & 63
UNC	64 & 65
UNF	64 & 65
BSW	66 & 67
BSF	66 & 67
BSPF (G Series)	68 & 69
BSPT (Rc Series)	68 & 69
NPT	68 & 69
NPSF	68

CARBON

TAPS & DIES - CARDED

Metric Coarse	70 & 71
Metric Fine	70 & 71
UNC	72 & 73
UNF	72 & 73
BSW	72 & 73
BSPF (G Series)	74
BSPT (Rc Series)	74
NPT	74

Kits	75
------	----

HSS

TAPS - BULK

Metric Coarse	76
Metric Fine	76
UNC	77
UNF	77
BSW	78
BSF	78
BSPF (G Series)	79
BSPT (Rc Series)	79
NPT	79
NPSF	79

HSS

TAPS - CARDED

Metric Coarse	80
UNC	80
UNF	80
BSW	80

HSSE

MACHINE TAPS - BULK

Metric Coarse	82
Metric Fine	82
UNC	83
UNF	83

Cutting Lubricant	81
-------------------	----

Wrenches	84
----------	----



Bulk

Carbon Taps



BULK

METRIC COARSE 

Thread ø mm	Pitch mm	OAL mm	Drill Size mm				SETS
				Taper	Intermediate	Bottoming	
M2	0.40	41	1.6	MCCT020	MCCI020	MCCB020	MCCS020
M3	0.50	48	2.5	MCCT030*	MCCI030*	MCCB030*	MCCS030
M4	0.70	53	3.3	MCCT040*	MCCI040*	MCCB040*	MCCS040
M5	0.80	58	4.2	MCCT050*	MCCI050*	MCCB050*	MCCS050
M6	1.00	66	5.0	MCCT060*	MCCI060*	MCCB060*	MCCS060
M7	1.00	66	6.0	MCCT070*	MCCI070*	MCCB070*	MCCS070
M8	1.25	72	6.8	MCCT080*	MCCI080*	MCCB080*	MCCS080
M9	1.25	72	7.8	MCCT090	MCCI090	MCCB090	MCCS090
M10	1.50	80	8.5	MCCT100*	MCCI100*	MCCB100*	MCCS100
M11	1.50	85	9.5	MCCT110	MCCI110	MCCB110	MCCS110
M12	1.75	89	10.2	MCCT120*	MCCI120*	MCCB120*	MCCS120
M14	2.00	95	12.0	MCCT140*	MCCI140*	MCCB140*	MCCS140
M16	2.00	102	14.0	MCCT160*	MCCI160*	MCCB160*	MCCS160
M18	2.50	112	15.5	MCCT180*	MCCI180*	MCCB180*	MCCS180
M20	2.50	112	17.0	MCCT200*	MCCI200*	MCCB200*	MCCS200
M22	2.50	118	19.5	MCCT220*	MCCI220*	MCCB220*	MCCS220
M24	3.00	130	21.0	MCCT240*	MCCI240*	MCCB240*	MCCS240
M27	3.00	135	24.0	MCCT270*	MCCI270*	MCCB270*	
M30	3.50	138	26.5	MCCT300	MCCI300	MCCB300	
M33	3.50	151	29.5	MCCT330	MCCI330	MCCB330	
M36	4.00	162	32.0	MCCT360	MCCI360	MCCB360	



BULK - 1 PCE

Supplied in plastic pack



BULK - TAP SET

Supplied 3 tap types per pack

METRIC FINE 

Thread ø mm	Pitch mm	OAL mm	Drill Size mm				SETS
				Taper	Intermediate	Bottoming	
MF8	1.00	72	7.0	MFCT080100	MFCI080100*	MFCB080100*	MFCS080100
MF10	1.00	80	9.0	MFCT100100*#	MFCI100100*#	MFCB100100#	MFCS100100#
MF10	1.25	80	8.8	MFCT100125*	MFCI100125*	MFCB100125*	MFCS100125
MF12	1.25	89	10.8	MFCT120125#	MFCI120125*#	MFCB120125#	MFCS120125#
MF12	1.50	89	10.5	MFCT120150	MFCI120150*	MFCB120150*	MFCS120150
MF14	1.25	95	12.8	MFCT140125*#	MFCI140125*#	MFCB140125*#	MFCS140125#
MF14	1.50	95	12.5	MFCT140150*	MFCI140150*	MFCB140150*	MFCS140150
MF16	1.50	102	14.5	MFCT160150*^	MFCI160150*^	MFCB160150*^	MFCS160150^
MF18	1.50	112	16.5	MFCT180150*#	MFCI180150*#	MFCB180150*#	MFCS180150#
MF20	1.50	112	18.5	MFCT200150*^	MFCI200150*^	MFCB200150*^	MFCS200150^
MF22	1.50	118	20.5	MFCT220150*	MFCI220150*	MFCB220150*	MFCS220150
MF24	2.00	130	22.0	MFCT240200*	MFCI240200*	MFCB240200*	MFCS240200
MF25	1.50	130	23.5	MFCT250150*^	MFCI250150*^	MFCB250150*^	MFCS250150^
MF32	1.50	151	30.0	MFCT320150^	MFCI320150^	MFCB320150^	

*Available carded - see page 70





#Spark Plug ^Conduit

Carbon Dies







BULK

METRIC COARSE 

Thread ø mm	Pitch mm	 1" OD	 1 1/2" OD	 2" OD	 Nut
M2	0.40	BDMCC020-1			
M3	0.50	BDMCC030-1*			DNMCC030
M4	0.70	BDMCC040-1*	BDMCC040-1.5*		DNMCC040
M5	0.80	BDMCC050-1*	BDMCC050-1.5*		DNMCC050*
M6	1.00	BDMCC060-1*	BDMCC060-1.5*		DNMCC060*
M7	1.00	BDMCC070-1*	BDMCC070-1.5*		DNMCC070*
M8	1.25	BDMCC080-1*	BDMCC080-1.5*		DNMCC080*
M9	1.25	BDMCC090-1*	BDMCC090-1.5*		DNMCC090
M10	1.50	BDMCC100-1*	BDMCC100-1.5*	BDMCC100-2	DNMCC100*
M11	1.50	BDMCC110-1*	BDMCC110-1.5*		
M12	1.75	BDMCC120-1*	BDMCC120-1.5*	BDMCC120-2	DNMCC120*
M14	2.00		BDMCC140-1.5*	BDMCC140-2	DNMCC140*
M16	2.00		BDMCC160-1.5*	BDMCC160-2	DNMCC160*
M18	2.50			BDMCC180-2	DNMCC180
M20	2.50			BDMCC200-2	DNMCC200
M22	2.50			BDMCC220-2	DNMCC220
M24	3.00			BDMCC240-2	DNMCC240
M27	3.00				DNMCC270
M30	3.50				DNMCC300
M33	3.50				DNMCC330
M36	4.00				DNMCC360

METRIC FINE 

Thread ø mm	Pitch mm	 1" OD	 1 1/2" OD	 2" OD	 Nut
MF8	1.00	BDMFC080-1*	BDMFC080-1.5*		DNMFC080
MF10	1.00	BDMFC100100-1*#	BDMFC100100-1.5*#		DNMFC100100*#
MF10	1.25	BDMFC100125-1*	BDMFC100125-1.5*		DNMFC100125
MF12	1.25	BDMFC120125-1*#	BDMFC120125-1.5*#	BDMFC120125-2*#	DNMFC120125*#
MF12	1.50	BDMFC120150-1*	BDMFC120150-1.5*	BDMFC120150-2*	DNMFC120150
MF14	1.25		BDMFC140125-1.5*#	BDMFC140125-2*#	
MF14	1.50		BDMFC140150-1.5*	BDMFC140150-2*	DNMFC140150
MF16	1.50			BDMFC160-2*^	DNMFC160^
MF18	1.50			BDMFC180-2*#	DNMFC180*#
MF20	1.50			BDMFC200-2*^	DNMFC200^
MF22	1.50			BDMFC220-2	DNMFC220
MF24	2.00			BDMFC240-2	DNMFC240
MF25	1.50			BDMFC250-2^	DNMFC250^

*Available carded- see page 71
 #Spark Plug ^Conduit



BULK - 1 PCE

Supplied in plastic pack

Bulk

Carbon Taps



BULK

UNC Unified National Coarse

ISO 529

Thread ø	TPI	OAL mm	Drill Size mm				SETS
				Taper	Intermediate	Bottoming	
5G	40	48	2.6	UNCCT5G	UNCCI5G	UNCCB5G	UNCCS5G
6G	32	50	2.8	UNCCT6G	UNCCI6G	UNCCB6G	UNCCS6G
8G	32	53	3.5	UNCCT8G	UNCCI8G	UNCCB8G	UNCCS8G
10G	24	58	3.9	UNCCT10G*	UNCCI10G*	UNCCB10G*	UNCCS10G
12G	24	62	4.5	UNCCT12G	UNCCI12G	UNCCB12G	UNCCS12G
3/16"	24 (UNS)	58	3.7	UNCCT316	UNCCI316*	UNCCB316*	UNCCS316
1/4"	20	66	5.1	UNCCT14*	UNCCI14*	UNCCB14*	UNCCS14
5/16"	18	72	6.6	UNCCT516*	UNCCI516*	UNCCB516*	UNCCS516
3/8"	16	80	8.0	UNCCT38*	UNCCI38*	UNCCB38*	UNCCS38
7/16"	14	85	9.4	UNCCT716*	UNCCI716*	UNCCB716*	UNCCS716
1/2"	13	89	10.8	UNCCT12*	UNCCI12*	UNCCB12*	UNCCS12
9/16"	12	95	12.2	UNCCT916*	UNCCI916*	UNCCB916*	UNCCS916
5/8"	11	102	13.5	UNCCT58*	UNCCI58*	UNCCB58*	UNCCS58
3/4"	10	112	16.5	UNCCT34*	UNCCI34*	UNCCB34*	UNCCS34
7/8"	9	118	19.5	UNCCT78*	UNCCI78*	UNCCB78*	UNCCS78
1"	8	130	22.0	UNCCT1*	UNCCI1*	UNCCB1*	UNCCS1
1 1/8"	7	138	25.0	UNCCT1-18	UNCCI1-18	UNCCB1-18	
1 1/4"	7	151	28.0	UNCCT1-14	UNCCI1-14	UNCCB1-14	



BULK - 1 PCE

Supplied in plastic pack



BULK - TAP SET

Supplied 3 tap types per pack

UNF Unified National Fine

ISO 529

Thread ø	TPI	OAL mm	Drill Size mm				SETS
				Taper	Intermediate	Bottoming	
5G	44	48	2.7	UNFCT5G	UNFCI5G	UNFCB5G	UNFCS5G
6G	40	50	2.9	UNFCT6G	UNFCI6G	UNFCB6G	UNFCS6G
8G	36	53	3.5	UNFCT8G	UNFCI8G	UNFCB8G	UNFCS8G
10G	32	58	4.1	UNFCT10G	UNFCI10G	UNFCB10G	UNFCS10G
12G	28	62	4.7	UNFCT12G	UNFCI12G	UNFCB12G	UNFCS12G
3/16"	32 (UNS)	58	4.1	UNFCT316	UNFCI316	UNFCB316	UNFCS316
1/4"	28	66	5.5	UNFCT14*	UNFCI14*	UNFCB14*	UNFCS14
5/16"	24	72	6.9	UNFCT516*	UNFCI516*	UNFCB516*	UNFCS516
3/8"	24	80	8.5	UNFCT38*	UNFCI38*	UNFCB38*	UNFCS38
7/16"	20	85	9.9	UNFCT716*	UNFCI716*	UNFCB716*	UNFCS716
1/2"	20	89	11.5	UNFCT12*	UNFCI12*	UNFCB12*	UNFCS12
9/16"	18	95	12.9	UNFCT916*	UNFCI916*	UNFCB916*	UNFCS916
5/8"	18	102	14.5	UNFCT58*	UNFCI58*	UNFCB58*	UNFCS58
3/4"	16	112	17.5	UNFCT34*	UNFCI34*	UNFCB34*	UNFCS34
7/8"	14	118	20.5	UNFCT78*	UNFCI78*	UNFCB78*	UNFCS78
1"	12	130	23.0	UNFCT1X12*	UNFCI1X12*	UNFCB1X12*	UNFCS1X12
	14	130	23.0	UNSC1X14*	UNSCI1X14*	UNSCB1X14*	UNSCS1X14
1 1/8"	12	138	26.5	UNFCT1-18	UNFCI1-18	UNFCB1-18	
1 1/4"	12	151	29.5	UNFCT1-14	UNFCI1-14	UNFCB1-14	
1 3/8"							
1 1/2"	12	170	36	UNFCT1-12	UNFCI1-12	UNFCB1-12	

*Available carded- see page 72

Carbon Dies



Bulk

BULK

UNC Unified National Coarse



Thread Ø	TPI				
		1" OD	1 1/2" OD	2" OD	Nut
5G	40	BDUNCC5G-1			
6G	32	BDUNCC6G-1			
8G	32	BDUNCC8G-1			
10G	24	BDUNCC10G-1			
12G	24	BDUNCC12G-1			
3/16"					
1/4"	20	BDUNCC14-1*	BDUNCC14-1.5*		DNUNCC14*
5/16"	18	BDUNCC516-1*	BDUNCC516-1.5*		DNUNCC516*
3/8"	16	BDUNCC38-1*	BDUNCC38-1.5*		DNUNCC38*
7/16"	14	BDUNCC716-1*	BDUNCC716-1.5*		DNUNCC716*
1/2"	13	BDUNCC12-1*	BDUNCC12-1.5*	BDUNCC12-2*	DNUNCC12*
9/16"	12		BDUNCC916-1.5	BDUNCC916-2	DNUNCC916
5/8"	11		BDUNCC58-1.5	BDUNCC58-2	DNUNCC58
3/4"	10			BDUNCC34-2	DNUNCC34
7/8"	9			BDUNCC78-2	DNUNCC78
1"	8			BDUNCC1-2	DNUNCC1
1 1/8"	7				DNUNCC1-18
1 1/4"	7				DNUNCC1-14
1 3/8"	6				DNUNCC1-38
1 1/2"	6				DNUNCC1-12
1 3/4"	5				DNUNCC1-34
2"	4.5				DNUNCC2

UNF Unified National Fine



Thread Ø	TPI				
		1" OD	1 1/2" OD	2" OD	Nut
5G	44	BDUNFC5G-1			
6G	40	BDUNFC6G-1			
8G	36	BDUNFC8G-1			
10G	32	BDUNFC10G-1			
12G	28	BDUNFC12G-1			
3/16"	32 (UNS)	BDUNFC316-1			
1/4"	28	BDUNFC14-1*	BDUNFC14-1.5*		DNUNFC14*
5/16"	24	BDUNFC516-1*	BDUNFC516-1.5*		DNUNFC516*
3/8"	24	BDUNFC38-1*	BDUNFC38-1.5*		DNUNFC38*
7/16"	20	BDUNFC716-1*	BDUNFC716-1.5*		DNUNFC716*
1/2"	20	BDUNFC12-1*	BDUNFC12-1.5*	BDUNFC12-2	DNUNFC12*
9/16"	18		BDUNFC916-1.5	BDUNFC916-2	DNUNFC916
5/8"	18		BDUNFC58-1.5	BDUNFC58-2	DNUNFC58
3/4"	16			BDUNFC34-2	DNUNFC34*
7/8"	14			BDUNFC78-2	DNUNFC78
1"	12			BDUNFC1X12-2	DNUNFC1X12
	14			BDUNSC1X14-2	DNUNSC1X14
1 1/8"	12				DNUNFC1-18
1 1/4"	12				DNUNFC1-14
1 3/8"	12				DNUNFC1-38

*Available carded- see page 73



BULK - 1 PCE

Supplied in plastic pack

Bulk

Carbon Taps



BULK

BSW British Standard Whitworth

ISO 529

Thread ø inches	TPI	OAL mm	Drill Size mm				SETS
				Taper	Intermediate	Bottoming	
1/8	40	48	2.5	BSWCT18*	BSWCI18*	BSWCB18*	BSWCS18
5/32	32	53	3.2	BSWCT532*	BSWCI532*	BSWCB532*	BSWCS532
3/16	24	58	3.7	BSWCT316*	BSWCI316*	BSWCB316*	BSWCS316
1/4	20	66	5.1	BSWCT14*	BSWCI14*	BSWCB14*	BSWCS14
5/16	18	72	6.5	BSWCT516*	BSWCI516*	BSWCB516*	BSWCS516
3/8	16	80	7.9	BSWCT38*	BSWCI38*	BSWCB38*	BSWCS38
7/16	14	85	9.3	BSWCT716*	BSWCI716*	BSWCB716*	BSWCS716
1/2	12	89	10.5	BSWCT12*	BSWCI12*	BSWCB12*	BSWCS12
9/16	12	95	12.1	BSWCT916	BSWCI916	BSWCB916	BSWCS916
5/8	11	102	13.5	BSWCT58	BSWCI58	BSWCB58	BSWCS58
3/4	10	112	16.0	BSWCT34	BSWCI34	BSWCB34	BSWCS34
7/8	9	118	19.0	BSWCT78	BSWCI78	BSWCB78	BSWCS78
1	8	130	22.0	BSWCT1	BSWCI1	BSWCB1	BSWCS1
1 1/8	7	138	25.0	BSWCT1-18	BSWCI1-18	BSWCB1-18	
1 1/4	7	151	28.0	BSWCT1-14	BSWCI1-14	BSWCB1-14	
1 3/8	6	162	30.0	BSWCT1-38	BSWCI1-38	BSWCB1-38	
1 1/2	6	170	33.5	BSWCT1-12	BSWCI1-12	BSWCB1-12	



BULK - 1 PCE
Supplied in plastic pack



BULK - TAP SET
Supplied 3 tap types per pack

BSF British Standard Fine

ISO 529

Thread ø inches	TPI	OAL mm	Drill Size mm				SETS
				Taper	Intermediate	Bottoming	
3/16	32	58	4.0	BSFCT316	BSFCI316	BSFCB316	BSFCS316
1/4	26	66	5.3	BSFCT14	BSFCI14	BSFCB14	BSFCS14
5/16	22	72	6.8	BSFCT516	BSFCI516	BSFCB516	BSFCS516
3/8	20	80	8.3	BSFCT38	BSFCI38	BSFCB38	BSFCS38
7/16	18	85	9.7	BSFCT716	BSFCI716	BSFCB716	BSFCS716
1/2	16	89	11.1	BSFCT12	BSFCI12	BSFCB12	BSFCS12
9/16	16	95	12.7	BSFCT916	BSFCI916	BSFCB916	BSFCS916
5/8	14	102	14.0	BSFCT58	BSFCI58	BSFCB58	BSFCS58
3/4	12	112	16.5	BSFCT34	BSFCI34	BSFCB34	BSFCS34
7/8	11	118	19.5	BSFCT78	BSFCI78	BSFCB78	BSFCS78
1	10	130	22.5	BSFCT1	BSFCI1	BSFCB1	BSFCS1

*Available carded- see page 72

Carbon Dies



BULK

BSW British Standard Whitworth

ISO 529

Thread ø inches	TPI				
		1" OD	1 1/2" OD	2" OD	Nut
1/8	40	BDBSWC18-1*			DNBSWC18*
5/32	32	BDBSWC532-1*			DNBSWC532*
3/16	24	BDBSWC316-1*	BDBSWC316-1.5*		DNBSWC316*
1/4	20	BDBSWC14-1*	BDBSWC14-1.5*		DNBSWC14*
5/16	18	BDBSWC516-1*	BDBSWC516-1.5*		DNBSWC516*
3/8	16	BDBSWC38-1*	BDBSWC38-1.5*		DNBSWC38*
7/16	14	BDBSWC716-1*	BDBSWC716-1.5*		DNBSWC716*
1/2	12	BDBSWC12-1*	BDBSWC12-1.5*	BDBSWC12-2	DNBSWC12*
9/16	12		BDBSWC916-1.5	BDBSWC916-2	DNBSWC916
5/8	11		BDBSWC58-1.5	BDBSWC58-2	DNBSWC58
3/4	10			BDBSWC34-2	DNBSWC34
7/8	9			BDBSWC78-2	DNBSWC78
1	8			BDBSWC1-2	DNBSWC1
1 1/8	7				DNBSWC1-18
1 1/4	7				DNBSWC1-14
1 3/8	6				DNBSWC1-12
1 1/2	6				DNBSWC1-34
2	4.5				DNBSWC2

BSF British Standard Fine

ISO 529

Thread ø inches	TPI				
		1" OD	1 1/2" OD	2" OD	Nut
3/16	32	BDBSFC316-1			DNBSFC316
1/4	26	BDBSFC14-1	BDBSFC14-1.5		DNBSFC14
5/16	22	BDBSFC516-1	BDBSFC516-1.5		DNBSFC516
3/8	20	BDBSFC38-1	BDBSFC38-1.5		DNBSFC38
7/16	18	BDBSFC716-1	BDBSFC716-1.5		DNBSFC716
1/2	16		BDBSFC12-1.5	BDBSFC12-2	DNBSFC12
9/16	16			BDBSFC916-2	DNBSFC916
5/8	14			BDBSFC58-2	DNBSFC58
3/4	12			BDBSFC34-2	DNBSFC34
7/8	11			BDBSFC78-2	DNBSFC78
1	10			BDBSFC1-2	DNBSFC1

*Available carded - see page 73



BULK - 1 PCE

Supplied in plastic pack

Bulk

Carbon Taps



BULK

BSPF British Standard Pipe Fitting
BSP (G Series)
ISO
228

Thread ø inches	TPI	OAL mm	Drill Size mm				SETS
				Taper	Intermediate	Bottoming	
1/8	28	59	8.8	BSPFCT18	BSPFCI18	BSPFCB18*	BSPFCS18
1/4	19	67	11.8	BSPFCT14	BSPFCI14	BSPFCB14	BSPFCS14
3/8	19	75	15.0	BSPFCT38	BSPFCI38	BSPFCB38	BSPFCS38
1/2	14	87	19.0	BSPFCT12	BSPFCI12	BSPFCB12	BSPFCS12
5/8	14	91	21.0	BSPFCT58	BSPFCI58	BSPFCB58	BSPFCS58
3/4	14	96	24.5	BSPFCT34	BSPFCI34	BSPFCB34	BSPFCS34
7/8	14	102	20.5				
1	11	109	30.5	BSPFCT1	BSPFCI1	BSPFCB1	BSPFCS1
1 1/4	11	119	39.5			BSPFCB1-14	
2	11	140	57.0	BSPFCT2	BSPFCI2	BSPFCB2	BSPFCS2



BULK - 1 PCE

Supplied in plastic pack



BULK - TAP SET

Supplied 3 tap types per pack

BSPT British Standard Pipe Taper
(Rc Series Pipe Taper)
ISO
228

Thread ø inches	TPI	OAL mm	Drill Size mm		
					Bottoming
1/8	28	59	8.4		BSPTCB18*
1/4	19	67	11.2		BSPTCB14*
3/8	19	75	14.5		BSPTCB38*
1/2	14	87	18.0		BSPTCB12*
3/4	14	96	23.5		BSPTCB34
1	11	109	30.0		BSPTCB1
1 1/4	11	119	38.5		BSPTCB1-14
1 1/2	11	125	44.5		BSPTCB1-12
2	11	140	56.0		BSPTCB2

NPT National Pipe Tapered
ANSI
B1.201

Thread ø inches	TPI	OAL mm	Drill Size mm		
					Bottoming
1/8	27	54	8.7		NPTCB18*
1/4	18	62	11.1		NPTCB14*
3/8	18	65	14.5		NPTCB38
1/2	14	79	18.0		NPTCB12
3/4	14	82	23.0		NPTCB34
1	11.5	95	29.0		NPTCB1
1 1/4	11.5	102	38.0		NPTCB1-14

NPSF (Dryseal)
National Pipe Straight Fuel
ANSI
B1.201

Thread ø inches	TPI	OAL mm	Drill Size mm			
				Taper	Intermediate	Bottoming
1/8	27	80	8.7	NPSFCT18	NPSFCI18	NPSFCB18
1/4	18	95	11.2	NPSFCT14		NPSFCB14
3/8	18	112	15.0	NPSFCT38	NPSFCI38	NPSFCB38
1/2	14	118	18.5	NPSFCT12	NPSFCI12	NPSFCB12

*Available carded- see page 74



Carbon Dies



BULK



BSPF

British Standard Pipe Fitting
BSP (G Series)ISO
228

Thread ø inches	TPI		 2" OD	 Nut
1/8	28		BDBSPFC18-2	
1/4	19		BDBSPFC14-2	DNBSPFC14
3/8	19		BDBSPFC38-2	DNBSPFC38
1/2	14		BDBSPFC12-2	DNBSPFC12
5/8	14		BDBSPFC58-2	DNBSPFC58
3/4	14		BDBSPFC34-2	DNBSPFC34
7/8	14		BDBSPFC78-2	
1	11		BDBSPFC1-2	DNBSPFC1

BSPT



British Standard Pipe Taper
(Rc Series Pipe Taper)ISO
228

Thread ø inches	TPI		 2" OD	 Nut
1/8	28		BDBSPTC18-2	DNBSPTC18
1/4	19		BDBSPTC14-2	DNBSPTC14
3/8	19		BDBSPTC38-2	DNBSPTC38
1/2	14		BDBSPTC12-2	DNBSPTC12
3/4	14		BDBSPTC34-2	DNBSPTC34
1	11			DNBSPTC1

NPT

National Pipe Taper

ANSI
B1.20.1

Thread ø inches	TPI		 2" OD	 Nut
1/8	27		BDNPTC18-2	
1/4	18		BDNPTC14-2	
3/8	18		BDNPTC38-2	
1/2	14		BDNPTC12-2	
3/4	14		BDNPTC34-2	



BULK - 1 PCE

Supplied in plastic pack

Carded

Carbon Taps



CARDED

METRIC COARSE 

Thread ø mm	Pitch mm	OAL mm	Drill Size mm			
				Taper	Intermediate	Bottoming
M3	0.50	48	2.5	CMCCT030	CMCCI030	CMCCB030
M4	0.70	53	3.3	CMCCT040	CMCCI040	CMCCB040
M5	0.80	58	4.2	CMCCT050	CMCCI050	CMCCB050
M6	1.00	66	5.0	CMCCT060	CMCCI060	CMCCB060
M7	1.00	66	6.0	CMCCT070	CMCCI070	CMCCB070
M8	1.25	72	6.8	CMCCT080	CMCCI080	CMCCB080
M9						
M10	1.50	80	8.5	CMCCT100	CMCCI100	CMCCB100
M11						
M12	1.75	89	10.2	CMCCT120	CMCCI120	CMCCB120
M14	2.00	95	12.0	CMCCT140	CMCCI140	CMCCB140
M16	2.00	102	14.0	CMCCT160	CMCCI160	CMCCB160
M18	2.50	112	15.5	CMCCT180	CMCCI180	CMCCB180
M20	2.50	112	17.0	CMCCT200	CMCCI200	CMCCB200
M22	2.50	118	19.5	CMCCT220	CMCCI220	CMCCB220
M24	3.00	130	21.0	CMCCT240	CMCCI240	CMCCB240
M27	3.00	135	24.0	CMCCT270	CMCCI270	CMCCB270



CARDED - 1 PCE
Supplied in
hangable card

METRIC FINE 

Thread ø mm	Pitch mm	OAL mm	Drill Size mm			
				Taper	Intermediate	Bottoming
MF8	1.00	72	7.0		CMFCI080100	CMFCB080100
MF10	1.00	80	9.0	CMFCT100100#	CMFCH100100#	
MF10	1.25	80	8.8	CMFCT100125	CMFCH100125	CMFCB100125
MF12	1.25	89	10.8		CMFCH120125#	
MF12	1.50	89	10.8		CMFCH120150	CMFCB120150
MF14	1.25	95	12.8	CMFCT140125#	CMFCH140125#	CMFCB140125#
MF14	1.50	95	12.5	CMFCT140150	CMFCH140150	CMFCB140150
MF16	1.50	102	14.5	CMFCT160150^	CMFCH160150^	CMFCB160150^
MF18	1.50	112	16.5	CMFCT180150#	CMFCH180150#	CMFCB180150#
MF20	1.50	112	18.5	CMFCT200150^	CMFCH200150^	CMFCB200150^
MF22	1.50	118	20.5	CMFCT220150	CMFCH220150	CMFCB220150
MF24	2.00	130	22.0	CMFCT240200	CMFCH240200	CMFCB240200
MF25	1.50	130	23.5	CMFCT250150^	CMFCH250150^	CMFCB250150^



#Spark Plug ^Conduit

Carbon Dies







CARDED

METRIC COARSE 

Thread ø mm	Pitch mm			 Nut
		 1" OD	 1 1/2" OD	
M3	0.50	CBDMCC030-1		
M4	0.70	CBDMCC040-1		CBDMCC040-1.5
M5	0.80	CBDMCC050-1		CBDMCC050-1.5 CDNMCC050
M6	1.00	CBDMCC060-1		CBDMCC060-1.5 CDNMCC060
M7	1.00	CBDMCC070-1		CBDMCC070-1.5 CDNMCC070
M8	1.25	CBDMCC080-1		CBDMCC080-1.5 CDNMCC080
M9	1.25	CBDMCC090-1		CBDMCC090-1.5
M10	1.50	CBDMCC100-1		CBDMCC100-1.5 CDNMCC100
M11	1.50	CBDMCC110-1		CBDMCC110-1.5
M12	1.75	CBDMCC120-1		CBDMCC120-1.5 CDNMCC120
M14	2.00			CBDMCC140-1.5 CDNMCC140
M16	2.00			CBDMCC160-1.5 CDNMCC160

METRIC FINE 

Thread ø mm	Pitch mm				 Nut
		 1" OD	 1 1/2" OD	 2" OD	
MF8	1.00	CBDMFC080-1		CBDMFC080-1.5	
MF10	1.00	CBDMFC100100-1 [#]		CBDMFC100100-1.5 [#]	CDNMFC100100 [#]
MF10	1.25	CBDMFC100125-1		CBDMFC100125-1.5	
MF12	1.25	CBDMFC120125-1 [#]		CBDMFC120125-1.5 [#]	CBDMFC120125-2 [#] CDNMFC120125 [#]
MF12	1.50	CBDMFC120150-1		CBDMFC120150-1.5	CBDMFC120150-2
MF14	1.25			CBDMFC140125-1.5 [#]	CBDMFC140125-2 [#]
MF14	1.50			CBDMFC140150-1.5	CBDMFC140150-2
MF16	1.50				CBDMFC160-2 [^]
MF18	1.50				CBDMFC180-2 [#] CDNMFC180 [#]
MF20	1.50				CBDMFC200-2 [^]

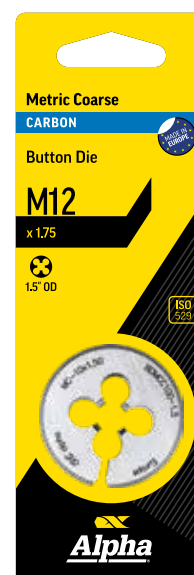
[#]Spark Plug [^]Conduit

CARDED - 1 PCE
Supplied in
hangable card

Carded

Carbon Taps



CARDED

UNC Unified National Coarse ISO 529

Thread ø	TPI	OAL mm	Drill Size mm	Tap		
				Taper	Intermediate	Bottoming
5G						
6G						
8G						
10G	24	58	3.9	CUNCCT10G	CUNCCI10G	CUNCCB10G
12G						
3/16"	24 (UNS)	58	3.7		CUNCCI316	CUNCCB316
1/4"	20	66	5.1	CUNCCT14	CUNCCI14	CUNCCB14
5/16"	20	72	6.6	CUNCCT516	CUNCCI516	CUNCCB516
3/8"	16	80	8.0	CUNCCT38	CUNCCI38	CUNCCB38
7/16"	14	85	9.4	CUNCCT716	CUNCCI716	CUNCCB716
1/2"	13	89	10.8	CUNCCT12	CUNCCI12	CUNCCB12
9/16"	12	95	12.2	CUNCCT916	CUNCCI916	CUNCCB916
5/8"	11	102	13.5	CUNCCT58	CUNCCI58	CUNCCB58
3/4"	10	112	16.5	CUNCCT34	CUNCCI34	CUNCCB34
7/8"	9	118	19.5	CUNCCT78	CUNCCI78	CUNCCB78
1"	8	130	22.0	CUNCCT1	CUNCCI1	CUNCCB1



CARDED - 1 PCE
Supplied in
hangable card

UNF Unified National Fine ISO 529 ANSI B94.9

Thread ø inches	TPI	OAL mm	Drill Size mm	Tap		
				Taper	Intermediate	Bottoming
1/4	28	66	5.5	CUNFCT14	CUNFCI14	CUNFCB14
5/16	24	72	6.9	CUNFCT516	CUNFCI516	CUNFCB516
3/8	24	80	8.5	CUNFCT38	CUNFCI38	CUNFCB38
7/16	20	85	9.9	CUNFCT716	CUNFCI716	CUNFCB716
1/2	20	89	11.5	CUNFCT12	CUNFCI12	CUNFCB12
9/16	18	95	12.9	CUNFCT916	CUNFCI916	CUNFCB916
5/8	18	102	14.5	CUNFCT58	CUNFCI58	CUNFCB58
3/4	16	112	17.5	CUNFCT34	CUNFCI34	CUNFCB34
7/8	14	118	20.5	CUNFCT78	CUNFCI78	CUNFCB78
1	12	130	23.0	CUNFCT1X12	CUNFCI1X12	CUNFCB1X12
	14	130	23.0	CUNFCT1X14	CUNFCI1X14	CUNFCB1X14

BSW British Standard Whitworth ISO 529

Thread ø inches	TPI	OAL mm	Drill Size mm	Tap		
				Taper	Intermediate	Bottoming
1/8	40	48	2.5	CBSWCT18	CBSWCI18	CBSWCB18
5/32	32	53	3.2	CBSWCT532	CBSWCI532	CBSWCB532
3/16	24	58	3.7	CBSWCT316	CBSWCI316	CBSWCB316
1/4	20	66	5.1	CBSWCT14	CBSWCI14	CBSWCB14
5/16	18	72	6.5	CBSWCT516	CBSWCI516	CBSWCB516
3/8	16	80	7.9	CBSWCT38	CBSWCI38	CBSWCB38
7/16	14	85	9.3	CBSWCT716	CBSWCI716	CBSWCB716
1/2	12	89	10.5	CBSWCT12	CBSWCI12	CBSWCB12

Carbon Dies



CARDED

UNC Unified National Coarse



Thread Ø	TPI				
		1" OD	1 1/2" OD	2" OD	Nut
5G	40	CBDUNCC5G-1			
6G	32	CBDUNCC6G-1			
8G	32	CBDUNCC8G-1			
10G	24	CBDUNCC10G-1			
12G	24	CBDUNCC12G-1			
3/16"					
1/4"	20	CBDUNCC14-1	CBDUNCC14-1.5		CDNUNCC14
5/16"	20	CBDUNCC516-1	CBDUNCC516-1.5		CDNUNCC516
3/8"	16	CBDUNCC38-1	CBDUNCC38-1.5		CDNUNCC38
7/16"	14	CBDUNCC716-1	CBDUNCC716-1.5		CDNUNCC716
1/2"	13	CBDUNCC12-1	CBDUNCC12-1.5	CBDUNCC12-2	CDNUNCC12
9/16"	12		CBDUNCC916-1.5	CBDUNCC916-2	
5/8"	11		CBDUNCC58-1.5	CBDUNCC58-2	
3/4"					
7/8"					
1"					

UNF Unified National Fine



Thread Ø inches	TPI				
		1" OD	1 1/2" OD		Nut
1/4	28	CBDUNFC14-1	CBDUNFC14-1.5		CDNUNFC14
5/16	24	CBDUNFC516-1	CBDUNFC516-1.5		CDNUNFC516
3/8	24	CBDUNFC38-1	CBDUNFC38-1.5		CDNUNFC38
7/16	20	CBDUNFC716-1	CBDUNFC716-1.5		CDNUNFC716
1/2	20	CBDUNFC12-1	CBDUNFC12-1.5		CDNUNFC12
9/16					
5/8					
3/4	16				CDNUNFC34
7/8					
1					

BSW British Standard Whitworth



Thread Ø inches	TPI				
		1" OD	1 1/2" OD		Nut
1/8	40	CBDBSWC18-1			CDNBSWC18
5/32	32	CBDBSWC532-1			CDNBSWC532
3/16	24	CBDBSWC316-1	CBDBSWC316-1.5		CDNBSWC316
1/4	20	CBDBSWC14-1	CBDBSWC14-1.5		CDNBSWC14
5/16	18	CBDBSWC516-1	CBDBSWC516-1.5		CDNBSWC516
3/8	16	CBDBSWC38-1	CBDBSWC38-1.5		CDNBSWC38
7/16	14	CBDBSWC716-1	CBDBSWC716-1.5		CDNBSWC716
1/2	12	CBDBSWC12-1	CBDBSWC12-1.5		CDNBSWC12

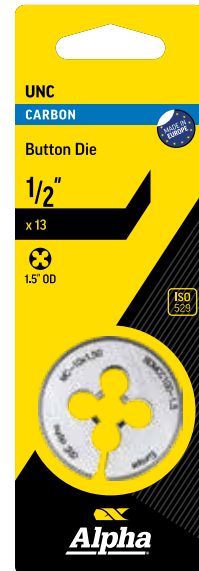

CARDED - 1 PCE
Supplied in
hangle card

Carded

Carbon Taps



CARDED - 1 PCE
Supplied in
hangable card

CARDED

BSPF British Standard Pipe Fitting BSP (G Series)				ISO 228
Thread ø inches	TPI	OAL mm	Drill Size mm	
				Taper Intermediate Bottoming
1/8	28	59	8.8	CBSPFGB18

BSPT British Standard Pipe Taper (Rc Series Pipe Taper)				ISO 228
Thread ø inches	TPI	OAL mm	Drill Size mm	
				Bottoming
1/8	28	59	8.4	CBSPTCB18
1/4	19	67	11.2	CBSPTCB14
3/8	19	75	14.5	CBSPTCB38
1/2	14	87	18.0	CBSPTCB12

NPT National Pipe Tapered				ANSI B1.20.1
Thread ø inches	TPI	OAL mm	Drill Size mm	
				Bottoming
1/8	27	54	8.7	CNPTCB18
1/4	18	62	11.1	CNPTCB14

Tap & Die Kits



- High carbon steel taps and dies in 17 sizes with accessories
- Precision manufactured to ISO and DIN standards
- Handy carry case

GENERAL PURPOSE



Light industrial, motor vehicle and construction

42 PCE

Metric Tap & Die Kit

Intermediate Taps & Button Dies

Metric:	M3 x 0.5	M3 x 0.6	M4 x 0.7	M4 x 0.75
	M5 x 0.8	M5 x 0.9	M6 x 0.75	M6 x 1.0
	M7 x 0.75	M7 x 1.0	M8 x 1.0	M8 x 1.25
	M10 x 1.25	M10 x 1.5	M12 x 1.5	M12 x 1.75

NPT: 1/8" x 27

Accessories: Tap wrench 1/8" - 1/2"
Die Stock - 1"
Screw Pitch Gauge
Centre Punch
T-type Tap Wrench
Screwdriver
Steel Brush

Code: TSM42

42 PCE

Imperial Tap & Die Kit

Intermediate Taps & Button Dies

UNS: 4G x 36

NPT: 1/8" x 27

UNC: 6G x 32 8G x 32 10G x 24 12G x 24 1/4" x 20
5/16" x 18 3/8" x 16 7/16" x 14 1/2" x 13

UNF: 10G x 32 1/4" x 28 5/16" x 24 3/8" x 24 7/16" x 20
1/2" x 20

Accessories: Tap wrench 1/8" - 1/2"
Die Stock - 1"
Screw Pitch Gauge
Centre Punch
T-type Tap Wrench
Screwdriver
Steel Brush

Code: TSI42

Bulk

HSS Taps



BULK

METRIC COARSE 

Thread ø mm	Pitch mm	OAL mm	Drill Size mm				
				Taper	Intermediate	Bottoming	SETS
M1.6	0.35	41	1.25		MCHI016		
M1.7	0.35	41	1.35		MCHI017		
M2	0.40	41	1.6	MCHT020	MCHI020	MCHB020	MCHS020
M2.5	0.45	45	2.05	MCHT025	MCHI025	MCHB025	MCHS025
M3	0.50	48	2.5	MCHT030*	MCHI030*	MCHB030*	MCHS030
M3.5	0.60	50	2.9	MCHT035	MCHI035	MCHB035	MCHS035
M4	0.70	53	3.3	MCHT040*	MCHI040*	MCHB040*	MCHS040
M4.5	0.75	53	3.7	MCHT045	MCHI045	MCHB045	MCHS045
M5	0.80	58	4.2	MCHT050*	MCHI050*	MCHB050*	MCHS050
M6	1.00	66	5.0	MCHT060*	MCHI060*	MCHB060*	MCHS060
M7	1.00	66	6.0	MCHT070*	MCHI070*	MCHB070*	MCHS070
M8	1.25	72	6.8	MCHT080*	MCHI080*	MCHB080*	MCHS080
M9	1.25	72	7.8	MCHT090*	MCHI090*	MCHB090*	MCHS090
M10	1.50	80	8.5	MCHT100*	MCHI100*	MCHB100*	MCHS100
M12	1.75	85	10.2	MCHT120*	MCHI120*	MCHB120*	MCHS120
M14	2.00	89	12.0	MCHT140	MCHI140	MCHB140	MCHS140
M16	2.00	102	14.0	MCHT160	MCHI160	MCHB160	MCHS160
M18	2.50	112	15.5	MCHT180	MCHI180	MCHB180	MCHS180
M20	2.50	112	17.0	MCHT200*	MCHI200	MCHB200*	MCHS200
M22	2.50	118	19.5	MCHT220	MCHI220	MCHB220	MCHS220
M24	3.00	130	21.0	MCHT240	MCHI240	MCHB240	MCHS240
M30	3.50	138	26.5	MCHT300	MCHI300	MCHB300	
M33	3.50	151	29.5	MCHT330	MCHI330	MCHB330	
M36	4.00	162	32.0	MCHT360	MCHI360	MCHB360	



BULK - 1 PCE

Supplied in plastic pack

BULK - TAP SET

Supplied 3 tap types per pack

METRIC COARSE - OVERSIZE/GALVANISING 

Thread ø mm	Pitch mm	OAL mm	Drill Size mm				
				Intermediate			
M12 + 0.4	1.75	89	10.6	MCHI120175			
M16 + 0.4	2.00	102	14.4	MCHI160200			
M20 + 0.4	2.50	112	17.9	MCHI200250			
M24 + 0.4	3.00	130	21.5	MCHI240300			

METRIC FINE 

Thread ø mm	Pitch mm	OAL mm	Drill Size mm				
				Taper	Intermediate	Bottoming	SETS
MF8	1.00	72	7.0	MFHT080100	MFHI080100	MFHB080100	MFHS080100
MF10	1.00	80	9.0	MFHT100100	MFHI100100	MFHB100100	MFHS100100
MF10	1.25	80	8.8	MFHT100125	MFHI100125	MFHB100125	MFHS100125
MF12	1.25	89	10.8	MFHT120125	MFHI120125	MFHB120125	MFHS120125
MF12	1.50	89	10.5	MFHT120150	MFHI120150	MFHB120150	MFHS120150
MF14	1.25	95	12.8	MFHT140125	MFHI140125	MFHB140125	MFHS140125
MF14	1.50	95	12.5	MFHT140150	MFHI140150	MFHB140150	MFHS140150
MF16	1.50	102	14.5	MFHT160150	MFHI160150	MFHB160150	MFHS160150
MF18	1.50	112	16.5	MFHT180150	MFHI180150	MFHB180150	MFHS180150
MF20	1.50	112	18.5	MFHT200150	MFHI200150	MFHB200150	MFHS200150
MF22	1.50	118	20.5	MFHT220150	MFHI220150	MFHB220150	MFHS220150
MF24	2.00	130	22.0	MFHT240200	MFHI240200	MFHB240200	MFHS240200
MF25	1.50	130	23.5	MFHT250150	MFHI250150	MFHB250150	MFHS250150

*Available carded- see page 80

HSS Taps



Bulk

BULK

UNC Unified National Coarse				ISO 529			
Thread ø	TPI	OAL mm	Drill Size mm				SETS
				Taper	Intermediate	Bottoming	
5G	40	48	2.6	UNCHT5G	UNCHI5G	UNCHB5G	UNCHS5G
6G	32	50	2.8	UNCHT6G	UNCHI6G	UNCHB6G	UNCHS6G
8G	32	53	3.5	UNCHT8G	UNCHI8G	UNCHB8G	UNCHS8G
10G	24	58	3.9	UNCHT10G	UNCHI10G	UNCHB10G	UNCHS10G
12G	24	62	4.5	UNCHT12G	UNCHI12G	UNCHB12G	UNCHS12G
3/16"	24 (UNS)	58	3.7	UNCHT316	UNCHI316	UNCHB316	UNCHS316
1/4"	20	66	5.1	UNCHT14*	UNCHI14*	UNCHB14*	UNCHS14
5/16"	18	72	6.6	UNCHT516*	UNCHI516*	UNCHB516*	UNCHS516
3/8"	16	80	8.0	UNCHT38*	UNCHI38*	UNCHB38*	UNCHS38
7/16"	14	85	9.4	UNCHT716*	UNCHI716*	UNCHB716*	UNCHS716
1/2"	13	89	10.8	UNCHT12*	UNCHI12*	UNCHB12*	UNCHS12
9/16"	12	95	12.2	UNCHT916	UNCHI916	UNCHB916	UNCHS916
5/8"	11	102	13.5	UNCHT58	UNCHI58	UNCHB58	UNCHS58
3/4"	10	112	16.5	UNCHT34	UNCHI34	UNCHB34	UNCHS34
7/8"	9	118	19.5	UNCHT78	UNCHI78	UNCHB78	UNCHS78
1"	8	130	22.0	UNCHT1	UNCHI1	UNCHB1	UNCHS1

UNF Unified National Fine				ISO 529		ANSI B94.9	
Thread ø	TPI	OAL mm	Drill Size mm				SETS
				Taper	Intermediate	Bottoming	
6G	40	50	2.9	UNFHT6G	UNFHI6G	UNFHB6G	UNFHS6G
8G	36	53	3.5	UNFHT8G	UNFHI8G	UNFHB8G	UNFHS8G
10G	32	58	4.1	UNFHT10G	UNFHI10G	UNFHB10G	UNFHS10G
12G	28	62	4.7	UNFHT12G	UNFHI12G	UNFHB12G	UNFHS12G
1/4"	28	66	5.5	UNFHT14*	UNFHI14*	UNFHB14*	UNFHS14
5/16"	24	72	6.9	UNFHT516*	UNFHI516*	UNFHB516*	UNFHS516
3/8"	24	80	8.5	UNFHT38*	UNFHI38*	UNFHB38*	UNFHS38
7/16"	20	85	9.9	UNFHT716*	UNFHI716*	UNFHB716*	UNFHS716
1/2"	20	89	11.5	UNFHT12*	UNFHI12*	UNFHB12*	UNFHS12
9/16"	18	95	12.9	UNFHT916	UNFHI916	UNFHB916	UNFHS916
5/8"	18	102	14.5	UNFHT58	UNFHI58	UNFHB58	UNFHS58
3/4"	16	112	17.5	UNFHT34	UNFHI34	UNFHB34	UNFHS34
7/8"	14	118	20.5	UNFHT78	UNFHI78	UNFHB78	UNFHS78
1"	12	130	23.0	UNFHT1	UNFHI1	UNFHB1	UNFHS1

*Available carded- see page 80



BULK - 1 PCE
Supplied in plastic pack



BULK - TAP SET
Supplied 3 tap types per pack

Bulk

HSS Taps



BULK

BSW British Standard Whitworth				ISO 529			
Thread ø inches	TPI	OAL mm	Drill Size mm				SETS
				Taper	Intermediate	Bottoming	
1/8	40	48	2.5	BSWHT18*	BSWHI18*	BSWHB18*	BSWHS18
5/32	32	53	3.2	BSWHT532*	BSWHI532*	BSWHB532*	BSWHS532
3/16	24	58	3.7	BSWHT316*	BSWHI316*	BSWHB316*	BSWHS316
1/4	20	66	5.1	BSWHT14*	BSWHI14*	BSWHB14*	BSWHS14
5/16	18	72	6.5	BSWHT516*	BSWHI516*	BSWHB516*	BSWHS516
3/8	16	80	7.9	BSWHT38*	BSWHI38*	BSWHB38*	BSWHS38
7/16	14	85	9.3	BSWHT716*	BSWHI716*	BSWHB716*	BSWHS716
1/2	12	89	10.5	BSWHT12*	BSWHI12*	BSWHB12*	BSWHS12
9/16	12	95	12.1	BSWHT916	BSWHI916	BSWHB916	BSWHS916
5/8	11	102	13.5	BSWHT58	BSWHI58	BSWHB58	BSWHS58
3/4	10	112	16.0	BSWHT34	BSWHI34	BSWHB34	BSWHS34
7/8	9	118	19.0	BSWHT78	BSWHI78	BSWHB78	BSWHS78
1	8	130	22.0	BSWHT1	BSWHI1	BSWHB1	BSWHS1
1 1/8	7	138	25.0	BSWHT1-18	BSWHI1-18	BSWHB1-18	
1 1/4	7	151	28.0	BSWHT1-14	BSWHI1-14	BSWHB1-14	
1 3/8	6	162	30.0	BSWHT1-38	BSWHI1-38	BSWHB1-38	
1 1/2	6	170	33.5	BSWHT1-12	BSWHI1-12	BSWHB1-12	
1 3/4	5	187	39.0	BSWHT1-34	BSWHI1-34	BSWHB1-34	
2	4.5	200	44.5	BSWHT2	BSWHI2	BSWHB2	



BULK - 1 PCE

Supplied in plastic pack



BULK - TAP SET

Supplied 3 tap types per pack

BSF British Standard Fine				ISO 529			
Thread ø inches	TPI	OAL mm	Drill Size mm				SETS
				Taper	Intermediate	Bottoming	
3/16	32	58	4.0	BSFHT316	BSFHI316	BSFHB316	BSFHS316
1/4	26	66	5.3	BSFHT14	BSFHI14	BSFHB14	BSFHS14
5/16	22	72	6.8	BSFHT516	BSFHI516	BSFHB516	BSFHS516
3/8	20	80	8.3	BSFHT38	BSFHI38	BSFHB38	BSFHS38
7/16	18	85	9.7	BSFHT716	BSFHI716	BSFHB716	BSFHS716
1/2	16	89	11.1	BSFHT12	BSFHI12	BSFHB12	BSFHS12
9/16	16	95	12.7	BSFHT916	BSFHI916	BSFHB916	BSFHS916
5/8	14	102	14.0	BSFHT58	BSFHI58	BSFHB58	BSFHS58
3/4	12	112	16.5	BSFHT34	BSFHI34	BSFHB34	BSFHS34
7/8	11	118	19.5	BSFHT78	BSFHI78	BSFHB78	BSFHS78
1	10	130	22.5	BSFHT1	BSFHI1	BSFHB1	BSFHS1

*Available carded- see page 80

HSS Taps



BULK

BSPF British Standard Pipe Fitting				ISO 529	ANSI B94.9		
Thread ø inches	TPI	OAL mm	Drill Size mm	Taper	Intermediate	Bottoming	SETS
1/8	28	59	8.8	BSPFHT18	BSPFHI18	BSPFHB18	BSPFHS18
1/4	19	67	11.8	BSPFHT14	BSPFHI14	BSPFHB14	BSPFHS14
3/8	19	75	15.0	BSPFHT38	BSPFHI38	BSPFHB38	BSPFHS38
1/2	14	87	19.0	BSPFHT12	BSPFHI12	BSPFHB12	BSPFHS12
5/8	14	91	21.0	BSPFHT58	BSPFHI58	BSPFHB58	BSPFHS58
3/4	14	96	24.5	BSPFHT34	BSPFHI34	BSPFHB34	BSPFHS34
7/8	14	102	28.0	BSPFHT78	BSPFHI78	BSPFHB78	BSPFHS78
1	11	109	30.5	BSPFHT1	BSPFHI1	BSPFHB1	BSPFHS1
1 1/4	11	119	39.5	BSPFHT1-14	BSPFHI1-14	BSPFHB1-14	
1 1/2	11	125	45.0	BSPFHT1-12			

BSPT British Standard Pipe Taper (Rc Series Pipe Taper)				ISO 529	ANSI B94.9		
Thread ø inches	TPI	OAL mm	Drill Size mm	Bottoming			
1/8	28	59	8.4	BSPTHB18			
1/4	19	67	11.2	BSPTHB14			
3/8	19	75	14.5	BSPTHB38			
1/2	14	87	18.0	BSPTHB12			
3/4	14	96	23.5	BSPTHB34			
1	11	109	30.0	BSPTHB1			
1 1/4	11	119	38.5	BSPTHB1-14			
1 1/2	11	125	44.5	BSPTHB1-12			
2	11	140	56.0	BSPTHB2			

NPT National Pipe Tapered				ISO 529	ANSI B94.9		
Thread ø inches	TPI	OAL mm	Drill Size mm	Bottoming			
1/8	27	54	8.7	NPTHB18			
1/4	18	62	11.1	NPTHB14			
3/8	18	65	14.5	NPTHB38			
1/2	14	79	18.0	NPTHB12			
3/4	14	82	23.0	NPTHB34			
1	11	95	29.0	NPTHB1			
1 1/4	11	102	38.0	NPTHB1-14			

NPSF (Dryseal) National Pipe Straight Fuel				ISO 529	ANSI B94.9		
Thread ø inches	TPI	OAL mm	Drill Size mm	Bottoming			
1/8	27	54	8.7	NPSFHB18			
1/4	18	62	11.2	NPSFHB14			
3/8	18	65	15.0	NPSFHB38			
1/2	14	79	18.5	NPSFHB12			



BULK - 1 PCE
Supplied in plastic pack



BULK - TAP SET
Supplied 3 tap types per pack

Carded

HSS Taps



CARDED

METRIC COARSE 

Thread ø mm	Pitch mm	OAL mm	Drill Size mm			
				Taper	Intermediate	Bottoming
M3	0.50	48	2.55	CMCHT030	CMCHI030	CMCHB030
M4	0.70	53	3.4	CMCHT040	CMCHI040	CMCHB040
M5	0.80	58	4.3	CMCHT050	CMCHI050	CMCHB050
M6	1.00	66	5.1	CMCHT060	CMCHI060	CMCHB060
M7	1.00	66	6.1	CMCHT070	CMCHI070	CMCHB070
M8	1.25	72	6.9	CMCHT080	CMCHI080	CMCHB080
M9	1.25	72	7.8	CMCHT090	CMCHI090	CMCHB090
M10	1.50	80	8.6	CMCHT100	CMCHI100	CMCHB100
M12	1.75	89	10.2	CMCHT120	CMCHI120	CMCHB120
M20	2.50	112	17	CMCHT200		CMCHB200

UNC Unified National Coarse 

Thread ø inches	TPI	OAL mm	Drill Size mm			
				Taper	Intermediate	Bottoming
1/4	20	66	5.1	CUNCHT14	CUNCHI14	CUNCHB14
5/16	18	72	6.6	CUNCHT516	CUNCHI516	CUNCHB516
3/8	16	80	8.0	CUNCHT38	CUNCHI38	CUNCHB38
7/16	14	85	9.4	CUNCHT716	CUNCHI716	CUNCHB716
1/2	13	89	10.8	CUNCHT12	CUNCHI12	CUNCHB12

UNF Unified National Fine  

Thread ø inches	TPI	OAL mm	Drill Size mm			
				Taper	Intermediate	Bottoming
1/4	28	66	5.5	CUNFHT14	CUNFHI14	CUNFHB14
5/16	24	72	6.9	CUNFHT516	CUNFHI516	CUNFHB516
3/8	24	80	8.5	CUNFHT38	CUNFHI38	CUNFHB38
7/16	20	85	9.9	CUNFHT716	CUNFHI716	CUNFHB716
1/2	20	89	11.5	CUNFHT12	CUNFHI12	CUNFHB12

BSW British Standard Whitworth 

Thread ø inches	TPI	OAL mm	Drill Size mm			
				Taper	Intermediate	Bottoming
1/8	40	48	2.5	CBSWHT18	CBSWHI18	CBSWHB18
5/32	32	53	3.2	CBSWHT532	CBSWHI532	CBSWHB532
3/16	24	58	3.7	CBSWHT316	CBSWHI316	CBSWHB316
1/4	20	66	5.1	CBSWHT14	CBSWHI14	CBSWHB14
5/16	18	72	6.5	CBSWHT516	CBSWHI516	CBSWHB516
3/8	16	80	7.9	CBSWHT38	CBSWHI38	CBSWHB38
7/16	14	85	9.3	CBSWHT716	CBSWHI716	CBSWHB716
1/2	12	89	10.5	CBSWHT12	CBSWHI12	CBSWHB12

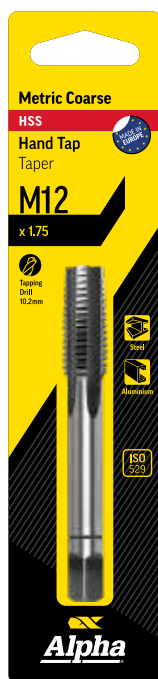

CARDED - 1 PCE
Supplied in
hangable card



C.D.T Cut.Drill.Tap Cutting Lubricant

Alpha C.D.T is formulated for extreme cutting performance when tapping, drilling or reaming into all metals, including hardened steel and titanium. Special additives reduce friction, extend tool life and provide excellent surface finish. Alpha C.D.T is water soluble, safe and easy to use.

- 250ml squeeze bottle
- Improves overall tool performance
- Non-flammable
- Environmentally safe
- Biodegradable ingredients
- Easy to use and clean up

Cutting Lubricant
250 ml

Code: ATL005

Bulk

HSSE Machine Taps





Spiral Point Tap



Spiral Flute Tap

BULK

METRIC COARSE

Thread ø mm	Pitch mm	OAL mm	Drill Size mm		
				Spiral Point Tap <i>Gun Nose</i>	Spiral Flute Tap
M3	0.50	56	2.5	MCESP030	MCESF030
M3.5	0.60	56	2.9	MCESP035	MCESF035
M4	0.70	63	3.3	MCESP040	MCESF040
M5	0.80	70	4.2	MCESP050	MCESF050
M6	1.00	80	5.0	MCESP060	MCESF060
M7	1.00	80	6.0	MCESP070	MCESF070
M8	1.25	90	6.8	MCESP080	MCESF080
M9	1.25	95	7.8	MCESP090	MCESF090
M10	1.50	100	8.5	MCESP100	MCESF100
M11	1.50	105	9.5	MCESP110	
M12	1.75	110	10.2	MCESP120	MCESF120
M14	2.00	110	12.0	MCESP140	MCESF140
M16	2.00	110	14.0	MCESP160	MCESF160
M18	2.50	125	15.5	MCESP180	MCESF180
M20	2.50	140	17.0	MCESP200	MCESF200
M22	2.50	140	19.5	MCESP220	MCESF220
M24	3.00	160	21.0	MCESP240	MCESF240
M27	3.00	160	24.0	MCESP270	
M30	3.50	180	26.5	MCESP300	
M33	3.50	180	29.5	MCESP330	
M36	4.00	200	32.0	MCESP360	



BULK - 1 PCE
Supplied in
plastic pack

METRIC FINE

Thread ø mm	Pitch mm	OAL mm	Drill Size mm		
				Spiral Point Tap <i>Gun Nose</i>	Spiral Flute Tap
MF5	0.50	70	4.5	MFESP050	MFESF050
MF6	0.75	80	5.2	MFESP060	MFESF060
MF8	1.00	90	7.0	MFESP080	MFESF080
MF10	1.00	90	9.0	MFESP100100	MFESF100100
MF10	1.25	100	8.8	MFESP100125	MFESF100125
MF12	1.25	100	10.5	MFESP120125	MFESF120125
MF12	1.50	100	10.5	MFESP120150	MFESF120150

HSSE Machine Taps







Spiral Point Tap



Spiral Flute Tap

BULK

UNC Unified National Coarse DIN 371					
Thread \varnothing	TPI	OAL mm	Drill Size mm	Spiral Point Tap <i>Gun Nose</i>	Spiral Flute Tap
6G	32	50	2.8	UNCESP6G	UNCESF6G
8G	32	53	3.5	UNCESP8G	UNCESF8G
10G	24	58	3.9	UNCESP10G	UNCESF10G
12G	24	62	4.5	UNCESP12G	UNCESF12G
1/4"	20	66	5.1	UNCESP14	UNCESF14
5/16"	18	72	6.6	UNCESP516	UNCESF516
3/8"	16	80	8.0	UNCESP38	UNCESF38
7/16"	14	85	9.4	UNCESP716	UNCESF716
1/2"	13	89	10.8	UNCESP12	UNCESF12
9/16"	12	95	12.2	UNCESP916	UNCESF916
5/8"	11	102	13.5	UNCESP58	UNCESF58
3/4"	10	112	16.5	UNCESP34	UNCESF34
7/8"	9	118	19.5	UNCESP78	UNCESF78
1"	8	130	22.0	UNCESP1	UNCESF1

UNF Unified National Fine DIN 371					
Thread \varnothing	TPI	OAL mm	Drill Size mm	Spiral Point Tap <i>Gun Nose</i>	Spiral Flute Tap
5G	44	48	2.7	UNFESP5G	UNFESF5G
6G	40	50	2.9	UNFESP6G	UNFESF6G
8G	36	53	3.5	UNFESP8G	UNFESF8G
10G	32	58	4.1	UNFESP10G	UNFESF10G
12G	28	62	4.7	UNFESP12G	UNFESF12G
1/4"	28	66	5.5	UNFESP14	UNFESF14
5/16"	24	72	6.9	UNFESP516	UNFESF516
3/8"	24	80	8.5	UNFESP38	UNFESF38
7/16"	20	85	9.9	UNFESP716	UNFESF716
1/2"	20	89	11.5	UNFESP12	UNFESF12
9/16"	18	95	12.9	UNFESP916	UNFESF916
5/8"	18	102	14.5	UNFESP58	UNFESF58
3/4"	16	112	17.5	UNFESP34	UNFESF34
7/8"	14	124	20.5	UNFESP78	UNFESF78
1"	12	139	23.0	UNFESP1	UNFESF1



BULK - 1 PCE
Supplied in plastic pack

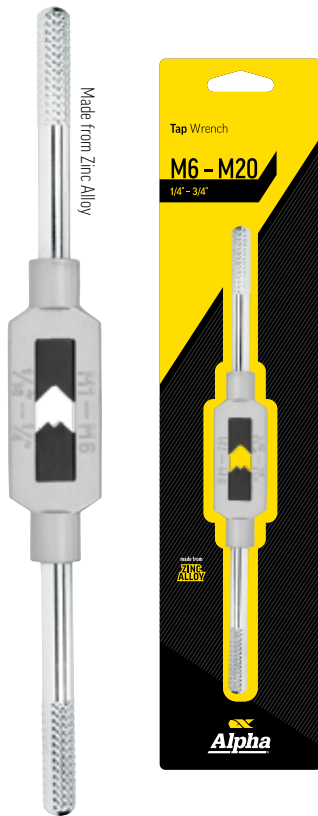

Tap Wrench

Tap Handle	Range mm	Range inches	Pack QTY	Code
00	M1 - M6	1/16" - 1/4"	1	TW-00
0	M3 - M12	1/8" - 1/2"	1	TW-0
#6	M6 - M20	1/4" - 3/4"	1	TW-6
#7	M10 - M25	3/8" - 1"	1	TW-7
#8	M20 - M38	1/4" - 1 1/2"	1	TW-8

TW-00, TW-0 & TW-6: CARDED - 1 PCE Supplied in hangable card
 TW-7 & TW-8: 1 PCE Supplied in plastic tube

T-Tap Wrench

Size inches	Range mm	Range inches	Pack QTY	Code
1/4	M3 - M6	1/8" - 1/4"	1	TW14
1/2	M6 - M12	5/16" - 1/2"	1	TW12

CARDED - 1 PCE Supplied in hangable card

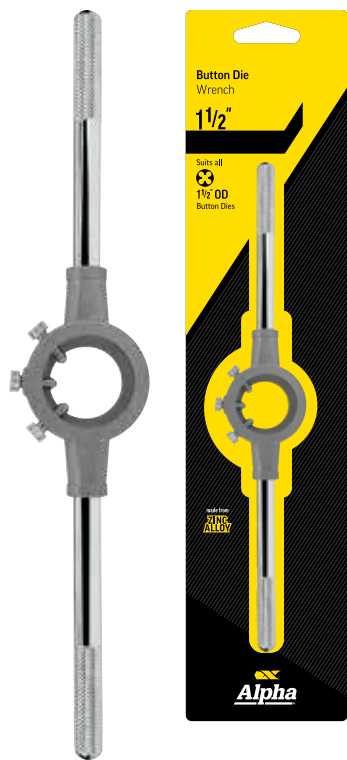

Ratchet **T-Tap** Wrench

Size inches	Range mm	Range inches	Pack QTY	Code
1/4	M3 - M6	1/8" - 1/4"	1	TW14R
1/2	M6 - M12	1/4" - 1/2"	1	TW12R

CARDED - 1 PCE Supplied in hangable card

Button Die Wrench

Size inches	Size mm	Pack QTY	Code
1	M25	1	BDW-1
1 1/2	M38	1	BDW-1.12
2	M51	1	BDW-2

BDW-1 & BDW-1.12: CARDED - 1 PCE Supplied in hangable card
 BDW-2: 1 PCE Supplied in plastic tube



Specialty

DiamondMAX Core Bits	89
Diamond Core Bits	90
Spearpoint Drills	91

Masonry

Masonry Drill Bits - Straight Shank	94
Multi-Purpose Drill Bits - Straight Shank	96
Multi-Purpose Drill Bits - Hex Shank	96
TCT Countersink Depth Gauge	97
2 HEAD CUT - SDS Plus	100
2 HEAD CUT - SDS Plus - TRADE	101
4 HEAD CUT - SDS Plus - ZENTRO®	102
4 HEAD CUT - SDS Max - ZENTRO®	103
SDS Max Core Cutter	104
Hollow Core Cutter	105
Chisels - TRADE	106
Plug Anchor - TRADE	106
Dreconnect Adaptor System	107
SDS Max to SDS Plus Adaptor	107



New
DiamondMAX Core Bits



Porcelain



Ceramic



Granite & Marble

Ideal for: WET OR DRY DRILLING: Porcelain, ceramic, granite, marble, limestone, slate, terracotta, fiberglass, travertine and masonry



Layered Diamond

Diamond composite technology enables the bit to be dressed for optimum performance

10x LIFE

Diamond segment tip reduces cutting temperature for 10x longer working life

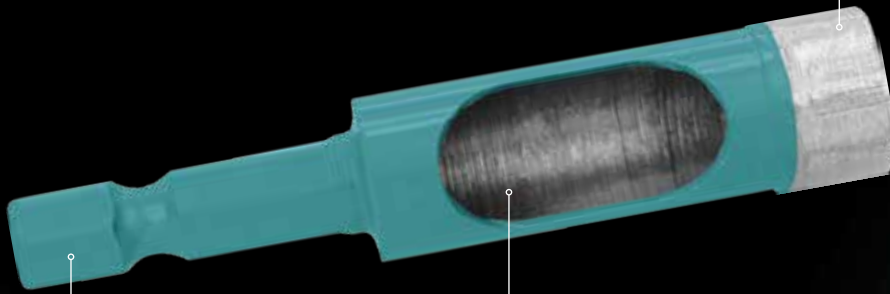

1/4" QUICK CHANGE

Wide slotted design for increased visibility while cutting and fast plug removal

New DiamondMAX Core Bits



DiamondMAX Core Bits

- Diamond segment tip reduces cutting temperature for 10x longer working life
 - Diamond composite technology enables the bit to be dressed for optimum performance
 - Wide slotted design for increased visibility while cutting and fast plug removal
- Cut Depth: 30mm



Layered Diamond
Diamond composite technology enables the bit to be dressed for optimum performance



CARDED METRIC

ø mm	OAL mm	Max RPM	CARDED 1 PCE
6	61	2,000	9DCDM060
8	61	1,500	9DCDM080
10	61	1,000	9DCDM100
12	61	950	9DCDM120

CARDED 1 PCE
Supplied in hangable card



All DiamondMax products include a bonus dressing stone



Ideal for cordless drills (no hammer action)



Drilling guide

5 PCE DiamondMAX Core Bit Set

Plastic Case Drill Set with drilling guide and BONUS dressing stone
Sizes: 6mm (x2), 8mm, 10mm & 12mm

Code: 9DCDM-SET

CORE BIT INSTRUCTIONS

Product packaging contains tips and full instructions



Step 1
When not using a drilling guide, start with a 45° angle to avoid the drill slipping.



Step 2
Gradually straighten to 90° once the drill is penetrating.



Step 3
Apply light pressure when drilling, making circular movements to allow for dust clearing.



Step 4
Remove core bit after drilling.

TRADIE TIP

To extend product life, if smoke appears while dry drilling, cease drilling and quench the tip and hole with water.



DRESSING STONE INSTRUCTIONS

To prevent clogging and prolong life of the core bit, drill into the dressing stone after use.



DRILLING INSTRUCTIONS

Alpha straight shank multi-purpose drill bits are suitable for sub-surface drilling and anchor fixing.

Diamond Core Bits



Ideal for: Porcelain, ceramic, granite, marble, limestone, slate, terracotta, fibreglass, travertine and masonry



Diamond coated design reduces cutting temperature for 5 times longer working life



Vacuum Brazed **Diamond Tip**



Suits: Non-hammer action portable power drills



Slotted design for increased visibility while cutting and fast plug removal (sizes 20mm - 35mm)

Wax filled core aids cooling and lubricates, eliminating the need for water (sizes 6mm - 12mm)



CARDED

DRY CUT - WAX FILLED



ø mm	OAL mm	Shank ø mm	Max RPM	CARDED 1 PCE
5	67	8	2,000	9DCD050
6	67	8	2,000	9DCD060
6.5	67	8	2,000	9DCD065
8	80	8	1,500	9DCD080
10	80	8	1,000	9DCD100
12	80	8	950	9DCD120

CARDED - 1 PCE
Supplied in hangable card



CARDED

WET CUT

ø mm	OAL mm	Shank ø mm	Max RPM	CARDED 1 PCE
15	80	8	875	9DCD150
20	80	8	825	9DCD200
25	80	10	700	9DCD250
30	80	10	675	9DCD300
35	80	10	600	9DCD350

CARDED - 1 PCE
Supplied in hangable card

STRAIGHT SHANK

Glass & Tile Spearpoint Drills



Glass



Ceramic

Ideal for: Drilling mirrors, glass
(excluding toughened glass)
and all ceramic tiles - including PEI4

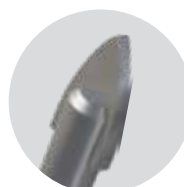

- Tungsten carbide tip stays sharper longer
- For best results use plenty of water

CARDED

METRIC					Suits
ø mm	ø inches	OAL mm	Max RPM	CARDED 1 PCE	
3	1/8	57	1,200	9GT030	
4	5/32	62	1,200	9GT040	
5	3/16	69	1,200	9GT050	
6	15/64	74	1,000	9GT060	
6.5	1/4	76	1,000	9GT065	
8	5/16	82	800	9GT080	
10	3/8	89	800	9GT100	
12	1/2	96	800	9GT120	

Suits: Non-hammer action portable power drills

CARDED - 1 PCE
Supplied in
hangable card



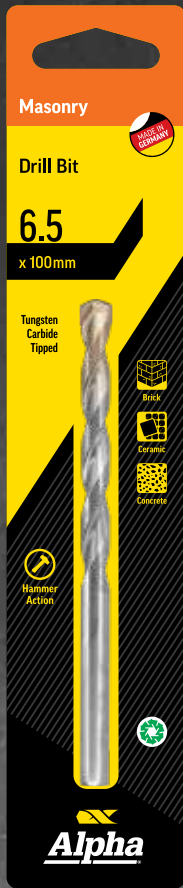

Available in 2 types: standard or German made

TCT Straight Shank Masonry

MASONRY



Brick



Ceramic



Concrete



Hammer Action

Ideal for: Brick, ceramic and concrete

Suits: Portable hammer action drills (standard jaw chuck)

TCT IMPACT Straight Shank Multi-Purpose

MULTI-PURPOSE



Wood



Metal



Masonry



Tiles



NO Hammer Action

Ideal for: Masonry, bricks, tiles, aerated concrete, wood, plastic and metal

Suits: Portable drills (standard jaw chuck) no hammer action



Masonry & Multi-Purpose Drill Bits

The Alpha masonry and multi-purpose drill bit range offers superior quality in a spectrum of product types.



A selection of sets are also available

TCT IMPACT Hex Shank Multi-Purpose

MULTI-PURPOSE



Ideal for: Masonry, bricks, tiles, aerated concrete, wood, plastic and metal

Suits: Impact drivers
no hammer action

TCT 
Straight Shank
Masonry Drill Bits

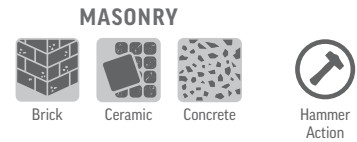

- Tungsten carbide tipped for longevity
- Made in Germany
- Suitable for rotary and impact drilling

CARDED
METRIC

ø mm	OAL mm	FL mm	Card QTY	CODE	Suits	
3.0	70	40	1	MA030070G		SF
	70	40	50 PACK	MA030070G50		SF
4.0	85	50	1	MA040085G		SF
5.0	85	50	1	MA050085G		SF
	150	90	1	MA050150G		SB
5.5	85	50	1	MA055085G		SF
	150	90	1	MA055150G		SB
6.0	100	60	1	MA060100G		SF
	150	90	1	MA060150G		SB
6.5	100	60	1	MA065100G		SF
	150	90	1	MA065150G		SB
7.0	150	90	1	MA070150G		SB
8.0	120	80	1	MA080120G		SF
	200	150	1	MA080200G		SB
9.0	120	80	1	MA090120G		SF
10.0	120	80	1	MA100120G		SF
	200	150	1	MA100200G		SB
12.0	150	90	1	MA120150G*		SB
	400	350	1	MA120400G*		DB
13.0	150	90	1	MA130150G*		SB
14.0	150	90	1	MA140150G*		SB
	400	350	1	MA140400G*		DB
16.0	160	100	1	MA160160G*		SB
	400	350	1	MA160400G*		DB
18.0	160	100	1	MA180160G*		SB
20.0	160	100	1	MA200160G*		SB

* 12mm shank

SF = Standard fitting
 SB = Single brick
 DB = Double brick

Ideal for: Brick, ceramic and concrete
Suits: Portable hammer action drills (standard jaw chuck)



CARDED - 1 PCE
 Supplied in
 hangable card



TCT Straight Shank Masonry Drill Bits



- Tungsten carbide tipped for longevity
- Suitable for rotary and impact drilling

CARDED

METRIC				Suits
ø mm	OAL mm	FL mm	CARDED 1 PCE	
3.0	65	32	MA030065	SF
3.5	75	37	MA035075	SF
4.0	75	37	MA040075	SF
4.5	65	37	MA045065	SF
	150	100	MA045150	SB
5.0	85	45	MA050085	SF
	150	90	MA050150	SB
5.5	85	45	MA055085	SF
	150	90	MA055150	SB
6.0	100	55	MA060100	SF
	150	90	MA060150	SB
6.5	100	55	MA065100	SF
	150	90	MA065150	SB
	300	200	MA065300	DB
7.0	100	55	MA070100	SF
8.0	120	70	MA080120	SF
	150	90	MA080150	SB
	300	200	MA080300	DB
10.0	120	70	MA100120	SF
	150	90	MA100150	SB
	400	267	MA100400	DB
11.0	150	90	MA110150	SB
12.0	150	90	MA120150*	SB
	400	267	MA120400*	DB
13.0	150	90	MA130150*	SB
14.0	210	150	MA140210*	SB
16.0	150	90	MA160150*	SB

* 12mm shank

SF - Standard fitting
SB - Single brick
DB - Double brick

CARDED - 1 PCE
Supplied in hangable card



5 PCE
Straight Shank,
Masonry Drill Set
Sizes: 6, 6.5, 8, 10 & 12mm (OAL 150mm)

Code: MA-SET5

Ideal for: Brick, ceramic and concrete
Suits: Portable hammer action drills (standard jaw chuck)

Drill Bits

MULTI-PURPOSE



CARDED - 1 PCE
Supplied in hangable card

TCT IMPACT Straight Shank Multi-Purpose Drill Bits



- Sharpened tungsten tipped for superior performance across a range of materials
- Made in Germany

CARDED

METRIC				Suits
Ø mm	OAL mm	FL mm	CARDED 1 PCE	
3.0	70	40	UNI030070	SF
4.0	85	50	UNI040085	SF
5.0	85	50	UNI050085	SF
5.5	85	50	UNI055085	SF
6.0	100	60	UNI060100	SF
6.5	100	60	UNI065100	SF
8.0	120	80	UNI080120	SF
	310	254	UNI080310	DB
10.0	120	80	UNI100120	SF
	310	254	UNI100310	DB
12.0	150	90	UNI120150	SB

Ideal for: Masonry, bricks, tiles, aerated concrete, wood, plastic and metal

SF = Standard fitting
SB = Single brick
DB = Double brick



MULTI-PURPOSE



CARDED - 1 PCE
Supplied in hangable card

TCT IMPACT Hex Shank Multi-Purpose Drill Bits



- Sharpened tungsten tipped for superior performance across a range of materials
- Made in Germany

CARDED

METRIC				Suits
Ø mm	OAL mm	FL mm	CARDED 1 PCE	
3.0	95	40	UNIHEX030	SF
4.0	105	50	UNIHEX040	SF
5.0	105	50	UNIHEX050	SF
5.5	105	55	UNIHEX055	SF
6.0	115	60	UNIHEX060	SF
6.5	115	60	UNIHEX065	SF
8.0	135	80	UNIHEX080	SF

SF = Standard fitting



5 PCE
Hex Shank, Masonry Drill Set
Sizes: 3 x 95mm, 5 x 105mm, 6 x 115mm, 6.5 x 115mm & 8 x 125mm
Code: UNIHEXSET5

Ideal for: Masonry, bricks, tiles, aerated concrete, wood, plastic and metal
Suits: Impact drivers (no hammer action)

TCT Countersink Depth Gauge Drill Bits

IDEAL FOR
CEMENT SHEET
& BLUE BOARD

- Drills and deburrs in one process
- Tungsten carbide tipped for extended life



SHALLOW
Depth Gauge



DEEP
Depth Gauge

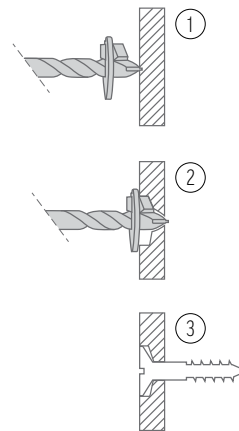

CARDED

SHALLOW 9mm cutting depth				Suits Screw Gauge
ø mm	Countersink ø mm	Countersink angle	CARDED 1 PCE	
5.0	11.00	90°	MADG0509	8G
6.0	11.00	90°	MADG0609	10G

DEEP 18mm cutting depth				Suits Screw Gauge
ø mm	Countersink ø mm	Countersink angle	CARDED 1 PCE	
5.0	11.00	90°	MADG0518	8G
6.0	11.00	90°	MADG0618	10G

CARDED
1 PCE
Supplied in
hangable card

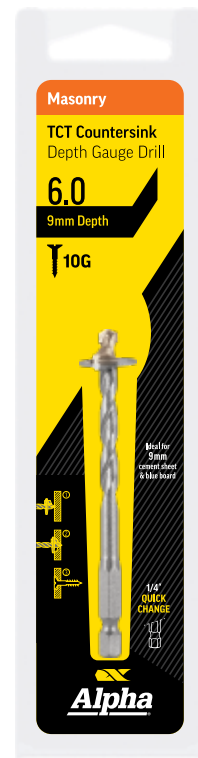

2 HEAD CUT

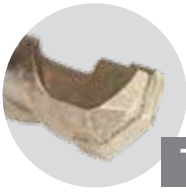

TRADE

SDS Plus
2 HEAD CUT



Certified Hole Accuracy

MASONRY

SDS Plus available in sizes 5 to 26mm

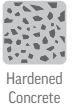

Hardened Concrete



Masonry

Ideal for: All masonry applications including hardened concrete

2 HEAD CUT

Quality 2 head design for the discerning tradesman or handyman

- Tungsten carbide tipped for longevity
- Strengthened flute

Suits: SDS rotary hammer drills



MADE IN GERMANY

SDS Plus
2 HEAD CUT



Certified Hole Accuracy

MASONRY

SDS Plus available in sizes 4 to 26mm



Hardened Concrete



Masonry

Ideal for: All masonry applications including hardened concrete

2 HEAD CUT

The dynamic chisel-shaped and centring tip provides optimal guidance while drilling

- Tungsten carbide tipped for longevity
- Strengthened flute

Suits: SDS rotary hammer drills



Wear markers indicate if the drill bit is still suited for drilling holes for plug and anchor fixtures



Concavely formed cutting faces ensure fast removal of drilling dust.



Distinct and aggressive centring tip allows for active centring and optimal guidance while drilling.



Innovative head design with short, straight flute entrance assures extremely fast progress providing a smooth and stable drilling process.



Certified Hole Accuracy



SDS Plus & SDS Max 4 HEAD CUT



SDS Plus available in sizes 5 to 32mm

SDS Max available in sizes 12 to 52mm



REO CONCRETE



Ideal for: All masonry applications including concrete with REO

4 HEAD CUT

Dynamic drilling ability, with secondary cutters protecting the drill bit in the event of reinforcement collision

- Tungsten carbide tipped for longevity
- Strengthened flute

Suits: SDS rotary hammer drills

Excellent performance in concrete with REO

Unique 4 head geometry ensures precision drill holes



Wear markers indicate if the drill bit is still suited for drilling holes for plug and anchor fixtures



4 x 90° geometry with four specifically developed cutting edges of equal height for precise, accurate holes for professional fixings.



Radially shaped edges for protection when hitting rebar, preventing jamming and increasing operational life.



Robust, one-piece carbide tip perforates rebar with permanent strength and constant precision.

SDS drill bits with PGM certification mark are suitable for the safe installation of anchor fixings in concrete and masonry. Their tolerances are tailored to metal, bonded and plastic anchors and anchors with European Technical Approval (ETA). This is not the case for drill bits without PGM mark. Their use can influence the safety and reliability of anchor fixings. If such drill bits are used, the liability risk for unsafe anchor fixings stays with the installer. Distributors take a higher liability risk when they sell drill bits without PGM certification mark.

2 HEAD CUT

SDS Plus

MADE IN GERMANY

2 HEAD CUT



Certified Hole Accuracy



Hardened Concrete



Masonry

IDEAL FOR ALL MASONRY APPLICATIONS INCLUDING HARDENED CONCRETE



1 PCE
Supplied on hang tag

10 PACK
Supplied in hangable plastic pack



5 PCE
2 HEAD CUT, SDS Plus Set
Sizes: 5, 6, 6.5, 8 & 10mm (OAL 160mm)

Code: SPSET-5

SDS PLUS

2 HEAD - METRIC

Ø mm	OAL mm	WL mm	HANG TAG 1 PCE	BULK 10 PACK
4	110	50	SP040110G	
	160	100	SP040160G	
5	110	50	SP050110G	SP050110GB
	160	100	SP050160G	SP050160GB
5.5	110	50	SP055110G	
	160	100	SP055160G	SP055160GB
	210	150	SP055210G	
6	110	50	SP060110G	SP060110GB
	160	100	SP060160G	SP060160GB
	210	150	SP060210G	
	260	200	SP060260G	
	310	250	SP060310G	
6.5	460	400	SP060460G	
	110	50	SP065110G	SP065110GB
	160	100	SP065160G	SP065160GB
	210	150	SP065210G	
7	260	200	SP065260G	
	310	250	SP065310G	
	110	50	SP070110G	
	160	100	SP070160G	
8	210	150	SP070210G	
	250	200	SP070250G	
	450	400	SP070450G	
	110	50	SP080110G	
9	160	100	SP080160G	SP080160GB
	210	150	SP080210G	
	260	200	SP080260G	
	310	250	SP080310G	
	460	400	SP080460G	
	600	550	SP080600G	
10	160	100	SP090160G	
	210	150	SP090210G	
	110	50	SP100110G	
	160	100	SP100160G	SP100160GB
	210	150	SP100210G	SP100210GB
11	260	200	SP100260G	
	310	250	SP100310G	
	350	300	SP100350G	
	450	400	SP100450G	
	600	550	SP100600G	
	1000	950	SP1001000G	
	160	100	SP110160G	
	260	200	SP110260G	
12	160	100	SP120160G	SP120160GB
	210	150	SP120210G	SP120210GB
	260	200	SP120260G	
	310	250	SP120310G	
	360	300	SP120360G	
	450	400	SP120450G	
	600	550	SP120600G	
	1000	950	SP1201000G	
13	160	100	SP130160G	
	210	150	SP130210G	
	260	200	SP130260G	
	310	250	SP130310G	
	450	400	SP130450G	
14	600	550	SP130600G	
	160	100	SP140160G	
	210	150	SP140210G	
	260	200	SP140260G	SP140260GB
15	310	250	SP140310G	
	450	400	SP140450G	
	600	550	SP140600G	
	1000	950	SP1401000G	
16	160	100	SP150160G	
	260	200	SP150260G	
	450	400	SP150450G	
	160	100	SP160160G	
	210	150	SP160210G	
17	260	200	SP160260G	
	310	250	SP160310G	
	450	400	SP160450G	
	600	550	SP160600G	
18	800	750	SP160800G	
	1000	950	SP1601000G	
	210	150	SP170210G	
19	200	150	SP180200G	
	300	250	SP180300G	
	450	400	SP180450G	
20	600	550	SP180600G	
	1000	950	SP1801000G	
	200	140	SP190200G	
21	450	400	SP190450G	
	200	150	SP200200G	
	300	250	SP200300G	
22	450	400	SP200450G	
	600	550	SP200600G	
	250	200	SP220250G	
23	450	400	SP220450G	
	600	550	SP220600G	
24	250	200	SP230450G	
	450	400	SP240450G	
25	250	200	SP240250G	
	450	400	SP250450G	
26	600	550	SP250600G	
	250	200	SP260250G	
27	450	400	SP260450G	
	600	550	SP260600G	



TRADE

SDS Plus 2 HEAD CUT



Hardened Concrete



Masonry

IDEAL FOR ALL MASONRY APPLICATIONS INCLUDING HARDENED CONCRETE



Certified Hole Accuracy

SDS PLUS

2 HEAD - TRADE - METRIC

ø mm	OAL mm	WL mm	HANG TAG 1 PCE
5	110	50	SP050110V
	160	100	SP050160V
	210	150	SP050210V
5.5	110	50	SP055110V
	160	100	SP055160V
	210	150	SP055210V
6	110	50	SP060110V
	160	100	SP060160V
	210	150	SP060210V
6.5	110	50	SP065110V
	160	100	SP065160V
	210	150	SP065210V
7	110	50	SP070110V
8	110	50	SP080110V
	160	100	SP080160V
	210	150	SP080210V
10	110	50	SP100110V
	160	100	SP100160V
	210	150	SP100210V
	260	200	SP100260V
	450	400	SP100450V
12	160	100	SP120160V
	210	150	SP120210V
	260	200	SP120260V
13	210	150	SP130210V

ø mm	OAL mm	WL mm	HANG TAG 1 PCE
14	210	150	SP140210V
	260	200	SP140260V
	310	250	SP140310V
	450	400	SP140450V
	600	550	SP140600V
15	160	100	SP150160V
	260	200	SP150260V
	450	400	SP150450V
16	160	100	SP160160V
	210	150	SP160210V
	260	200	SP160260V
18	210	150	SP180210V
20	200	140	SP200200V
	310	250	SP200310V
	600	550	SP200600V
22	250	200	SP220250V
	450	400	SP220450V
	600	550	SP220600V
24	260	200	SP240260V
26	260	200	SP260260V



1 PCE
Supplied on
hang tag



4 HEAD CUT

ZENTRO®
SDS Plus
4 HEAD CUT



IDEAL FOR ALL MASONRY APPLICATIONS INCLUDING CONCRETE WITH REO



1 PCE
 Supplied on hang tag

SDS PLUS

4 HEAD ZENTRO® - METRIC

Ø mm	OAL mm	WL mm	HANG TAG 1 PCE
5	110	50	SPZ050110
	160	100	SPZ050160
5.5	110	50	SPZ055110
	160	100	SPZ055160
6	110	50	SPZ060110
	160	100	SPZ060160
6.5	110	50	SPZ065110
	160	100	SPZ065160
8	110	50	SPZ080110
	160	100	SPZ080160
10	110	50	SPZ100110
	160	100	SPZ100160
12	210	150	SPZ100210
	260	200	SPZ100260
13	160	100	SPZ120160
	210	150	SPZ120210
14	260	200	SPZ120260
	310	250	SPZ120310
15	450	400	SPZ120450
	310	250	SPZ130310
16	260	200	SPZ140260
	450	400	SPZ140450
18	210	150	SPZ150210
	160	100	SPZ160160
20	260	200	SPZ160260
	450	400	SPZ160450
22	250	200	SPZ180250
	450	400	SPZ180450
24	250	200	SPZ200250
	450	400	SPZ200450
25	250	200	SPZ220250
	450	400	SPZ220450
28	250	200	SPZ240250
	450	400	SPZ240450
30	250	200	SPZ250250
	450	400	SPZ250450
32	250	200	SPZ280250
	450	400	SPZ280450
30	250	200	SPZ300250
	450	400	SPZ300450
32	450	400	SPZ320450



5 PCE
 4 HEAD CUT, SDS Plus
 ZENTRO® Set
 Sizes: 5, 6, 6.5, 8 & 10mm
 (OAL 160mm)

Code: SPZSET-5

SDS PLUS

4 HEAD ZENTRO® - IMPERIAL

Ø inches	OAL inches	OAL mm	WL inches	HANG TAG 1 PCE
3/8	6 1/4	160	100	SPZ138X160
	12 1/4	310	260	SPZ112X310
1/2	18	450	400	SPZ112X450

SDS Max drills are recommended for all drilling applications above 20mm diameter





SDS Max 4 HEAD CUT



IDEAL FOR ALL MASONRY APPLICATIONS INCLUDING CONCRETE WITH REO



Certified Hole Accuracy

SDS MAX

4 HEAD ZENTRO® - METRIC

ø mm	OAL mm	WL mm	TUBE 1 PCE	ø mm	OAL mm	WL mm	TUBE 1 PCE
12	340	200	SXZ12340	28	370	250	SXZ28370
	540	400	SXZ12540		570	450	SXZ28570
14	340	200	SXZ14340		920	800	SXZ28920
	540	400	SXZ14540	1320	1200	SXZ281320*	
15	340	200	SXZ15340	30	370	250	SXZ30370
	540	400	SXZ15540		570	450	SXZ30570
16	340	200	SXZ16340	32	370	250	SXZ32370
	540	400	SXZ16540		570	450	SXZ32570
	940	800	SXZ16920		920	800	SXZ32920
	1320	1180	SXZ161320*	1320	1200	SXZ321320*	
	1620	1480	SXZ161620*	35	370	250	SXZ35370
2500	2360	SXZ162500*	570		450	SXZ35570	
18	340	200	SXZ18340		920	800	SXZ35920
	540	400	SXZ18540	1320	1200	SXZ351320*	
	940	800	SXZ18920	37	570	450	SXZ37570
1320	1180	SXZ181320*	370		250	SXZ38370	
20	320	200	SXZ20320	38	570	450	SXZ38570
	520	400	SXZ20520		370	250	SXZ40370
	920	800	SXZ20920	40	570	450	SXZ40570
22	320	200	SXZ22320		920	800	SXZ40920
	520	400	SXZ22520		1320	1200	SXZ401320*
	920	800	SXZ22920	45	570	450	SXZ45570
1320	1200	SXZ221320*	50		570	450	SXZ50570
24	320	200		SXZ24320	52	570	450
	520	400	SXZ24520				
25	320	200	SXZ25320				
	520	400	SXZ25520				
	920	800	SXZ25920				
	1320	1200	SXZ251320*				
26	520	400	SXZ26520				

*supplied in flexipack



1 PCE
Supplied in hangable plastic tube



SDS Max Core Cutter

SDS Max Core Cutter



IDEAL FOR ALL MASONRY APPLICATIONS INCLUDING **NATURAL STONE**

New generation core bit

Aggressive tooth geometry and dynamic outside cutting ring for optimised performance when drilling into rebar

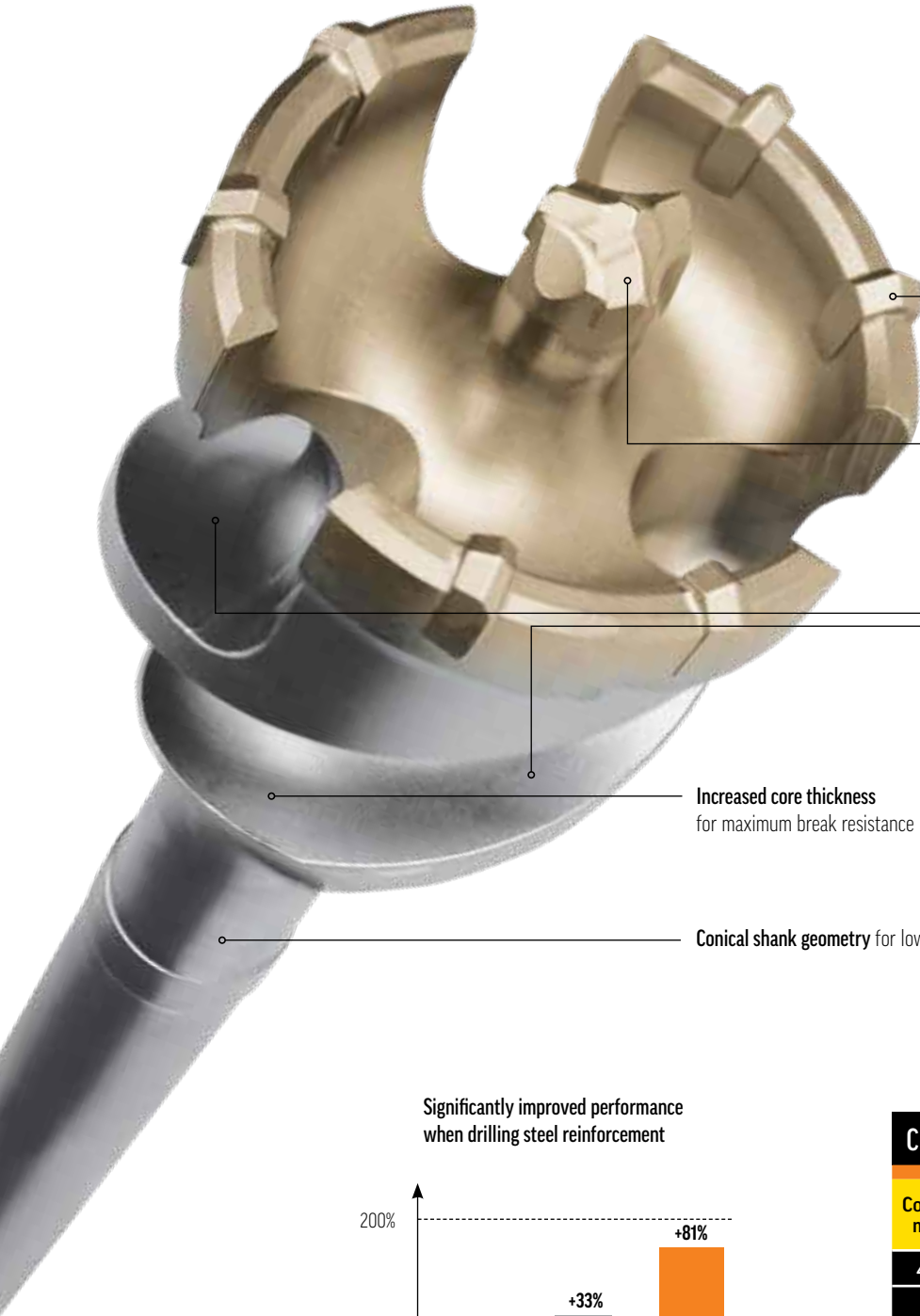

Roof shaped **carbide teeth** for fast drilling

Massive centring bit with 3-cutter geometry for:

- precise drilling
- optimised performance when drilling in rebar
- extreme break resistant performance

Optimised flute design removes debris efficiently

Increased core thickness for maximum break resistance

Conical shank geometry for low vibration drilling

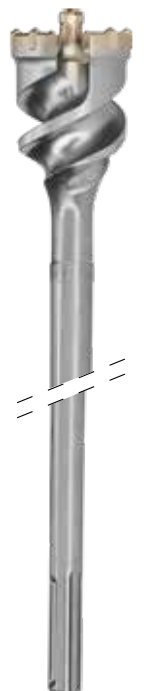

Significantly improved performance when drilling steel reinforcement

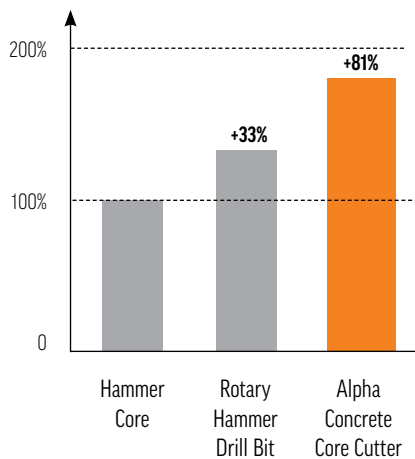

CORE CUTTER		
Core ø mm	OAL mm	CODE 1 PCE
40	550	CCC40X550
	310	CCC45X310
45	550	CCC45X550
	310	CCC55X310
55	550	CCC55X550
	310	CCC65X310
65	310	CCC65X310
	550	CCC65X550
80	310	CCC80X310
	550	CCC80X550

Suits: SDS Max rotary hammer drills

Hollow Core Cutter



IDEAL FOR ALL MASONRY APPLICATIONS INCLUDING **NATURAL STONE**

- Asymmetrical tooth arrangement produces different impact patterns of the teeth, resulting in higher efficiency and faster drilling progress
- Sharp tooth cutting edge geometry for extremely fast drilling progress and clean drilled holes
- Easy removal of the drill core and separation of the core bit from the adapter
- Increased carbide tip protrusion and chamfer on the toothed crown prevent jamming of the drill bit in the drilled hole
- Centring drill bit for easy, precise spot drilling
- Special set screw with internal hexagon prevents the loosening of the centring drill bit during drilling



Hollow Core Bit



HOLLOW CORE BIT		
Core ø mm	OAL mm	CODE 1 PCE
30	58	HCB30X58
40	58	HCB40X58
45	58	HCB45X58
50	50	HCB50X50
65	50	HCB65X50
80	50	HCB80X50
90	50	HCB90X50
100	50	HCB100X50

SDS Plus Shank Adaptor



ADAPTOR		
OAL mm	Thread mm	CODE 1 PCE
105	M16	SPADP105
220	M16	SPADP220
370	M16	SPADP370

Centring Pilot Drill



CENTRING PILOT		
Drill ø mm	OAL mm	CODE 1 PCE
8	120	CDP080120

Chisels & Anchor

TRADE

Chisels



IDEAL FOR ALL MASONRY APPLICATIONS INCLUDING HARDENED CONCRETE



Suits: SDS rotary hammer drills



1 PCE
Supplied on hang tag

TRADE

Plug Anchor



Suits: SDS rotary hammer drills



IDEAL FOR ALL MASONRY APPLICATIONS INCLUDING HARDENED CONCRETE



1 PCE
Supplied on hang tag

POINTED CHISEL		
Shank	OAL mm	HANG TAG 1 PCE
SDS Plus	250	SPPC250V
SDS Max	280	SXPC280V
	400	SXPC400V

SPADE CHISEL			
Shank	Width mm	OAL mm	HANG TAG 1 PCE
SDS Plus	40	250	SPSC40250V
SDS Max	80	300	SXSC80300V
	50	400	SXSC50400V

PLUG ANCHOR			
Shank	Width mm	OAL mm	HANG TAG 1 PCE
SDS Plus	15	135	SPA15135

FLAT CHISEL			
Shank	Width mm	OAL mm	HANG TAG 1 PCE
SDS Plus	20	250	SPFC20250V
SDS Max	25	280	SXFC25280V
	25	400	SXFC25400V

HOLLOW CHISEL			
Shank	Width mm	OAL mm	HANG TAG 1 PCE
SDS Plus	22	250	SPHOL250V
SDS Max	26	300	SXHOL300V

DRECONNECT Adaptor System

Allows any SDS drill to take any SDS Max attachment and extends the reach of SDS Max tools

- **No energy loss normally encountered in conventional adaptor systems** and full transmission of energy to the drill bit tip
- **No weak points** and therefore no breakages due to excessive strain in the coupling area

Ideal for Alpha's SDS Max range:
Zentro® 4 HEAD CUT, core cutters and chisels

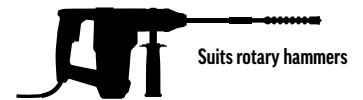

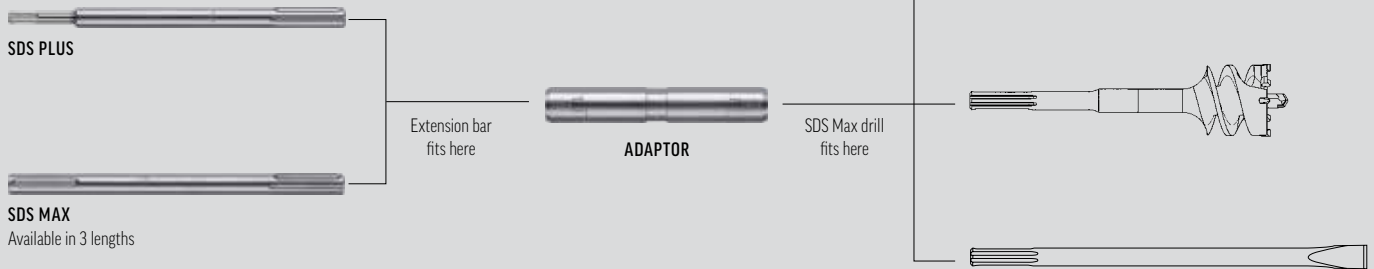

Select the extension to suit your rotary hammer



Hex, SDS top and SDS spline also available on special order



SDS PLUS EXTENSION  



OAL mm	Description	CODE 1 PCE
320	SDS Plus to SDS Max	EXSPSX320



SDS ADAPTOR 

OAL mm	ø mm	Description	CODE 1 PCE
190	30	Double sided SDS Max chuck	SXSXCON



SDS MAX EXTENSION  

OAL mm	Description	CODE 1 PCE
320	SDS Max to SDS Max	EXSXSX320
750	SDS Max to SDS Max	EXSXSX750
1100	SDS Max to SDS Max	EXSXSX1100

Adaptor SDS Max to SDS Plus



SDS MAX TO SDS PLUS ADAPTOR

OAL mm	Description	CODE 1 PCE
220	SDS Max to SDS Plus Adaptor	SX-SPADP

Suits: SDS rotary hammer impact drills

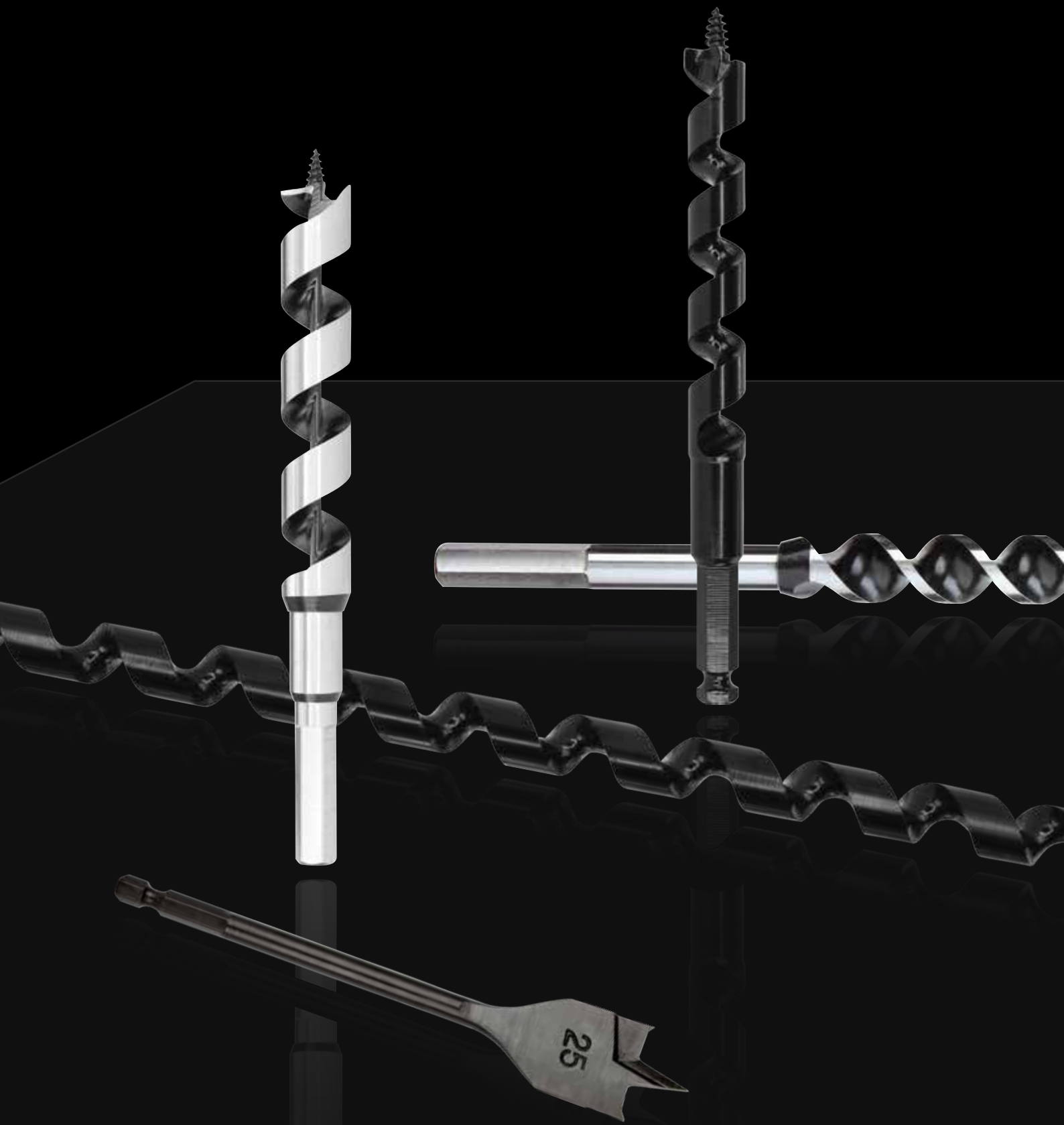

Timber

4 Cutter Augers - 4 MAX	111
Spade Bits - TurboBORE	112
Extension Bars	113
Heavy Duty Augers	115
Scotch Augers	116
Shipper Augers	117
Merchandisers	118



4 Cutter Auger Bits – 4 MAX



Cutting spurs reduce splintering for a smoother finish

4x
FASTER

4 cutting edges cut 4x faster than standard spade bits

Coarse screw tip for effortless feed in hard and soft woods

Short flute design for fast chip ejection

Full length heat treatment for increased durability

4 MAX
4 Cutter Auger Bits

4 MAX

4 Cutter Auger Bits



Hardwood & Softwood

- Four cutting edges cut 4x faster than standard spade bits
- Cutting spurs reduce splintering for a smoother finish
- Coarse screw tip for effortless feed in hard and soft woods
- Full length heat treatment for increased durability
- Short flute design for fast chip ejection



QUICK CHANGE

4x FASTER
than standard spade bits

CARDED

HEX					Suitable Extension Bar Range
ø mm	OAL mm	FL mm	Shank ø	CARDED 1 PCE	
10	165	45	1/4	TS4C-10	TS08 see page 113
13	165	45	1/4	TS4C-13	
16	165	45	1/4	TS4C-16	
19	165	45	1/4	TS4C-19	
20	165	45	1/4	TS4C-20	
22	165	45	1/4	TS4C-22	
25	165	45	1/4	TS4C-25	WAH-EXT see page 113
32	165	45	7/16	TS4C-32*	

CARDED 1 PCE
Supplied in hangable card

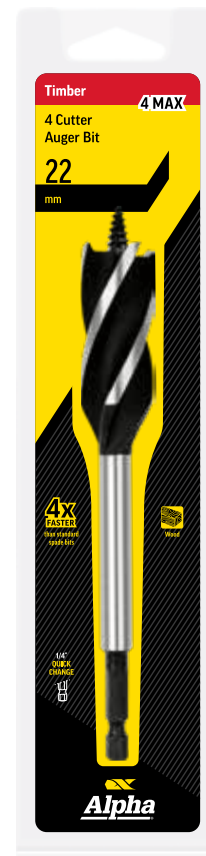

4 MAX

4 Cutter Auger Bit Sets

3 PCE SET: 16 – 25mm size range

Sizes: 16, 19 & 25mm

Code: TS4C-SET3

5 PCE SET: 16 – 32mm size range

Sizes: 16, 19, 22, 25 & 32mm

Code: TS4C-SET5

Spade Bits - TurboBORE

TurboBORE Spade Bits



Hardwood & Softwood



1/4" QUICK CHANGE

- Relief ground point and cutting edge ensures fast drilling
- Double outside spurs provide a cleaner hole and reduce vibration
- Forged from one piece of high carbon steel
- Self-starting point
- Non-slip 1/4" quick change



CARDED
1 PCE
Supplied on hangable card

CARDED

1/4" HEX			Suitable Extension Bar Range
Ø mm	Ø inches	CARDED 1 PCE	
6	1/4	TS08-06	TS08 see page 113
8	5/16	TS08-08	
10	3/8	TS08-10	
12	1/2	TS08-12	
13	33/64	TS08-13	
14	9/16	TS08-14	
15	9/32	TS08-15	
16	5/8	TS08-16	
18	11/16	TS08-18	
19	3/4	TS08-19	
20	13/16	TS08-20	
22	7/8	TS08-22	
24	15/16	TS08-24	
25	1	TS08-25	
28	1 1/8	TS08-28	
30	1 3/16	TS08-30	
32	1 1/4	TS08-32	
35	1 3/8	TS08-35	
38	1 1/2	TS08-38	
40	1 9/16	TS08-40	

1/4" HEX LONG SPADE BIT 400mm		
Ø mm	Ø inches	HANG TAG 1 PCE
10	3/8	TS08L-10
13	33/64	TS08L-13
16	5/8	TS08L-16
19	3/4	TS08L-19*
26	1 1/8	TS08L-26*

*Strengthened shaft

1 PCE
Supplied on hang tag

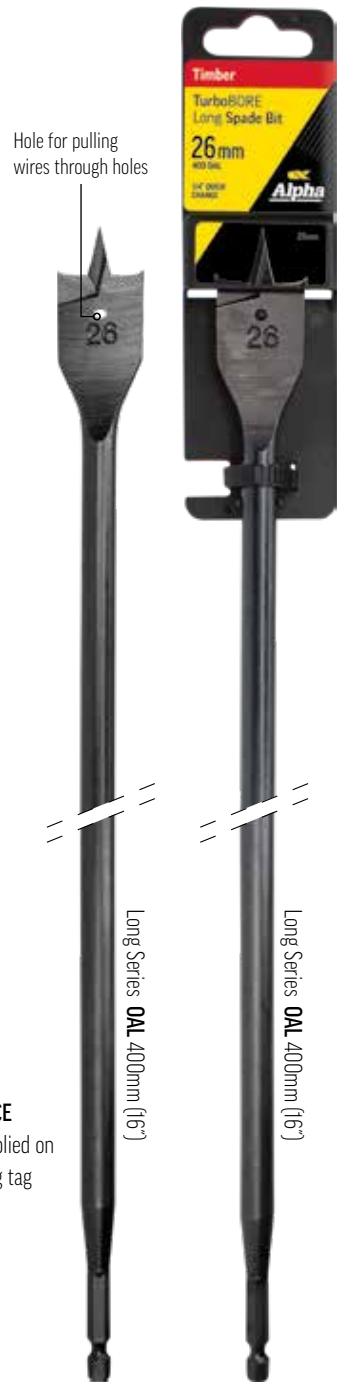

8 PCE TurboBORE Spade Bit Set

- CONTAINS:
- 1 x 150mm Quick Release Extension Bar (TS08-QREXT150)
 - 7 x TurboBORE Spade Bits: 10, 12, 16, 20, 22, 25 & 32mm
 - Sturdy plastic storage case

Code: TS08-SET8



Extension Bars Quick Release

- **Tapered head design** guides extension bar through holes (17mm and up)
- Quick release head for efficient bit changing

Suits a wide variety of 1/4" hex accessories

Head size: 17mm

OAL mm	HANG TAG 1 PCE
150	TS08-QREXT150
300	TS08-QREXT300
450	TS08-QREXT450
600	TS08-QREXT600
900	TS08-QREXT900

1 PCE

Supplied on hang tag



Extension Bars Grub Screw

Supplied with allen key

Suits all 1/4" hex accessories

Head size: 12mm

OAL mm	HANG TAG 1 PCE
150	TS08-EXT150
300	TS08-EXT300

1 PCE

Supplied on hang tag



Heavy Duty Extension Bars Grub Screw

Supplied with allen key

Suits all 7/16" hex accessories

OAL mm	TUBE 1 PCE
140	WAH-EXT140
305	WAH-EXT305
460	WAH-EXT460

1 PCE

Supplied in hangable plastic tube

Suits: Heavy Duty Augers (WAH range)

Holesaw Arbor (ARB-2)

Holesaw Arbor Kit (ARB-5)

Heavy Duty Auger Bits



Hardened self-feeding screw for durability, easy starting and fast drilling

Ultra-hard cutting edge for fast drilling and longevity

Non-stick coating reduces friction, increases product life and productivity

Strengthened core structure provides increased bit rigidity



HEAVY DUTY

Ideal for power poles, fence posts and railway sleepers



Hardwood & Softwood

7/16"



Heavy Duty Auger Bits



New label design maximises staff and customer selection



Solid plastic protects drill bits

Transparent tube for maximum drill visibility

New cuboid packaging provides clear bit size labelling and easy storage



OAL 205mm

OAL 330mm

OAL 457mm

OAL 600mm

4 LENGTHS AVAILABLE

Heavy Duty Auger Bits

Heavy Duty Auger Bits

METRIC					Suitable Extension Bar Range
ø mm	ø inches	OAL mm	FL mm	TUBE 1 PCE	
10	3/8	205	120	WAH100205	WAH see page 113
	3/8	330	240	WAH100330	
	3/8	457	362	WAH100457	
	3/8	600	510	WAH100600	
11	7/16	205	120	WAH110205	
	7/16	330	240	WAH110330	
	7/16	457	362	WAH110457	
	7/16	600	510	WAH110600	
12	15/32	205	120	WAH120205	
	15/32	457	362	WAH120457	
	15/32	600	510	WAH120600	
12.7	1/2	205	120	WAH127205	
	1/2	330	240	WAH127330	
	1/2	457	362	WAH127457	
	1/2	600	510	WAH127600	
14	9/16	205	120	WAH140205	
	9/16	330	240	WAH140330	
	9/16	457	362	WAH140457	
	9/16	600	510	WAH140600	
16	5/8	205	120	WAH160205	
	5/8	330	237	WAH160330	
	5/8	457	362	WAH160457	
	5/8	600	510	WAH160600	
18	23/32	205	120	WAH180205	
	23/32	330	237	WAH180330	
	23/32	457	362	WAH180457	
	23/32	600	510	WAH180600	
19	3/4	205	120	WAH190205	
	3/4	330	237	WAH190330	
	3/4	457	362	WAH190457	
	3/4	600	510	WAH190600	
22	7/8	205	120	WAH220205	
	7/8	330	235	WAH220330	
	7/8	457	362	WAH220457	
	7/8	600	510	WAH220600	
25	1	205	135	WAH250205	
	1	330	235	WAH250330	
	1	457	370	WAH250457	
	1	600	510	WAH250600	
26	1 1/32	457	362	WAH260457	
29	1 6/64	205	120	WAH290205	
	1 6/64	330	234	WAH290330	
	1 6/64	457	375	WAH290457	
	1 6/64	600	520	WAH290600	
32	1 17/64	205	120	WAH320205	
	1 17/64	330	234	WAH320330	
	1 17/64	457	362	WAH320457	
	1 17/64	600	510	WAH320600	



Hardwood
& Softwood

**IDEAL FOR
POWER POLES
FENCE POSTS &
RAILWAY SLEEPERS**

**HEAVY
DUTY**



**7/16"
QUICK
CHANGE**

Ideal for drilling hardwood and softwood

Engineered for fast, smooth,
extra heavy-duty drilling:

- Hardened screw tip for durability
- Strengthened core structure
- Single cutting edge

Shank: 7/16" quick change

**Non-stick coating increases
product life and productivity**
by providing:

- Smoother, low friction drilling
- Faster chip ejection
- Reduction of wear
- Protection against corrosion



1 PCE
Supplied in
hanging plastic
tube

New

Scotch Auger Bits



IDEAL FOR THE
CONSTRUCTION
INDUSTRY



Hardwood
& Softwood

Scotch Auger Bits

- Perfect for general purpose use
- Thin web design for minimum resistance
- Open flute for enhanced chip removal
- Two cutting edges

METRIC

Ø mm	Ø inches	OAL mm	FL mm	Hex Shank mm	TUBE 1 PCE
6	1/4	230	140	6	WAS060230*
8	5/16	230	140	6	WAS080230*
10	3/8	220	130	8	WAS100220*
11	7/16	330	240	8	WAS110330*
	7/16	440	350	8	WAS110440*
12	1/2	330	240	10	WAS120330*
12.7	1/2	230	140	10	WAS127230*
14	9/16	230	140	10.8	WAS140230*
	5/8	220	130	10.8	WAS160220*
16	5/8	330	240	10.8	WAS160330*
	5/8	330	240	10.8	WAS170330*
17	5/8	330	240	10.8	WAS170330*
18	23/32	230	140	10.8	WAS180230*
	3/4	220	130	10.8	WAS190220*
19	3/4	330	240	10.8	WAS190330*
	3/4	440	350	10.8	WAS190440*
20	25/32	220	130	10.8	WAS200220*
	25/32	330	240	10.8	WAS200330*
21	13/16	220	130	10.8	WAS210220*
	13/16	330	240	10.8	WAS210330*
22	7/8	220	130	10.8	WAS220220*
	7/8	330	240	10.8	WAS220330*
25	1	220	130	10.8	WAS250220*
	1	330	240	10.8	WAS250330*
	1	440	350	10.8	WAS250440*
30	1 3/16	330	240	10.8	WAS300330*
32	1 1/4	440	350	10.8	WAS320440*

1 PCE
Supplied in
hanging plastic
tube



Suits: Non-hammer action portable power drills

*While stocks last

Shipper Auger Bits



IDEAL FOR
SOFTWOOD,
KILN DRIED TIMBER
& MANUFACTURED
BOARDS

- Single spur cutting edge reduces resistance for smooth splinter free holes
- Solid central core for increased bit rigidity

METRIC

ø mm	ø inches	OAL mm	FL mm	Hex Shank mm	TUBE 1 PCE
6	1/4	200	130	5	WA060200
	1/4	450	390	5	WA060450*
8	5/16	200	130	6	WA080200
	5/16	450	390	6	WA080450*
10	3/8	200	130	8	WA100200
	3/8	460	390	8	WA100450
	3/8	600	530	8	WA100600*
11	7/16	200	130	8	WA110200*
12	1/2	200	130	10	WA120200
	1/2	450	390	10	WA120450
	1/2	600	530	10	WA120600*
14	9/16	200	130	10.8	WA140200
	9/16	450	390	10.8	WA140450
	9/16	600	530	10.8	WA140600*
15	19/32	200	130	10.8	WA150200
16	5/8	200	130	10.8	WA160200
	5/8	450	390	10.8	WA160450
	5/8	600	530	10.8	WA160600*
18	23/32	200	130	10.8	WA180200
	23/32	450	390	10.8	WA180450
	23/32	600	530	10.8	WA180600*
19	3/4	200	130	10.8	WA190200
20	25/32	200	130	10.8	WA200200
	25/32	450	390	10.8	WA200450*
	25/32	600	530	10.8	WA200600*
21	53/64	210	140	10.8	WA210210
22	7/8	200	130	10.8	WA220200
	7/8	450	390	10.8	WA220450*
24	15/16	200	130	10.8	WA240200
	15/16	450	390	10.8	WA240450*
	15/16	600	530	10.8	WA240600*
25	1	200	130	10.8	WA250200
	1	450	390	10.8	WA250450*
	1	600	530	10.8	WA250600*
26	1	200	130	10.8	WA260200
	1	600	530	10.8	WA260600*
28	1 1/8	200	130	10.8	WA280200
	1 1/8	450	390	10.8	WA280450*
	1 1/8	600	530	10.8	WA280600*
30	1 3/16	200	130	10.8	WA300200
	1 3/16	450	390	10.8	WA300450*
	1 3/16	600	530	10.8	WA300600*
32	1 1/4	200	130	10.8	WA320200
34	1 5/16	600	530	10.8	WA340600*
35	1 3/8	200	360	10.8	WA350200
36	1 7/16	200	360	10.8	WA360200
	1 7/16	600	530	10.8	WA360600*



1 PCE
Supplied in
hangable plastic
tube



OAL
200mm

OAL
450mm

OAL
600mm

3 LENGTHS AVAILABLE

Suits: Non-hammer action portable power drills

*While stocks last



Size (mm): 600W x 420H x 270D



Merchandiser

Spade Bit & Extension Bar Merchandiser

28 SKUS

84 items

MERCHANDISER ITEM	SIZE	Items per pack	CODE	QTY
TurboBORE Spade Bit	6mm	1 PCE	TS08-06	3
	8mm	1 PCE	TS08-08	3
	10mm	1 PCE	TS08-10	3
	12mm	1 PCE	TS08-12	3
	13mm	1 PCE	TS08-13	3
	14mm	1 PCE	TS08-14	3
	15mm	1 PCE	TS08-15	3
	16mm	1 PCE	TS08-16	3
	18mm	1 PCE	TS08-18	3
	19mm	1 PCE	TS08-19	3
	20mm	1 PCE	TS08-20	3
	22mm	1 PCE	TS08-22	3
	24mm	1 PCE	TS08-24	3
	25mm	1 PCE	TS08-25	3
	28mm	1 PCE	TS08-28	3
	30mm	1 PCE	TS08-30	3
	32mm	1 PCE	TS08-32	3
35mm	1 PCE	TS08-35	3	
38mm	1 PCE	TS08-38	3	
40mm	1 PCE	TS08-40	3	

MERCHANDISER ITEM	SIZE	Items per pack	CODE	QTY
TurboBORE Long Spade Bit	10mm	1 PCE	TS08L-10	3
	13mm	1 PCE	TS08L-13	3
	16mm	1 PCE	TS08L-16	3
	19mm	1 PCE	TS08L-19	3
	26mm	1 PCE	TS08L-26	3
TurboBORE QUICK RELEASE Extension Bars	150mm	1 PCE	TS08-QREXT150	3
	300mm	1 PCE	TS08-QREXT300	3
	450mm	1 PCE	TS08-QREXT450	3

Code: SPAD-28-DISP



Product packaging and merchandiser for maximum store impact

Size (mm):
600W x 420H x 270D

Heavy Duty Auger Bit Merchandiser

33 SKUS
33 items

HEAVY DUTY AUGER	OAL	Items per tube	CODE	QTY
10mm	205mm	1 PCE	WAH100205	1
	330mm	1 PCE	WAH100330	1
	457mm	1 PCE	WAH100457	1
12mm	205mm	1 PCE	WAH120205	1
	457mm	1 PCE	WAH120457	1
12.7mm	205mm	1 PCE	WAH127205	1
	330mm	1 PCE	WAH127330	1
	457mm	1 PCE	WAH127457	1
14mm	205mm	1 PCE	WAH140205	1
	330mm	1 PCE	WAH140330	1
	457mm	1 PCE	WAH140457	1
16mm	205mm	1 PCE	WAH160205	1
	330mm	1 PCE	WAH160330	1
	457mm	1 PCE	WAH160457	1
18mm	205mm	1 PCE	WAH180205	1
	330mm	1 PCE	WAH180330	1
	457mm	1 PCE	WAH180457	1
19mm	205mm	1 PCE	WAH190205	1
	330mm	1 PCE	WAH190330	1
	457mm	1 PCE	WAH190457	1

HEAVY DUTY AUGER	OAL	Items per tube	CODE	QTY
22mm	205mm	1 PCE	WAH220205	1
	330mm	1 PCE	WAH220330	1
	457mm	1 PCE	WAH220457	1
25mm	205mm	1 PCE	WAH250205	1
	330mm	1 PCE	WAH250330	1
29mm	457mm	1 PCE	WAH250457	1
	205mm	1 PCE	WAH290205	1
32mm	330mm	1 PCE	WAH290330	1
	457mm	1 PCE	WAH290457	1
Heavy Duty Extension Bar	205mm	1 PCE	WAH320205	1
	330mm	1 PCE	WAH320330	1
	457mm	1 PCE	WAH320457	1
Heavy Duty Extension Bar	305mm	1 PCE	WAH-EXT305	1

Code: WAH-33-DISP



Holesaws & Hole Cutters

Bi-Metal Holesaws - White Pointer	125
Bi-Metal Holesaw Kits - White Pointer	127
TCT Holesaws	128
TCT Holesaw Kits	129
Bristol Bi-Metal Holesaw Kits	130
Arbors, Sets & Pilot Drills	131
Pro Lock	133
HSS Hole Cutters	134
TCT Hole Cutters	135

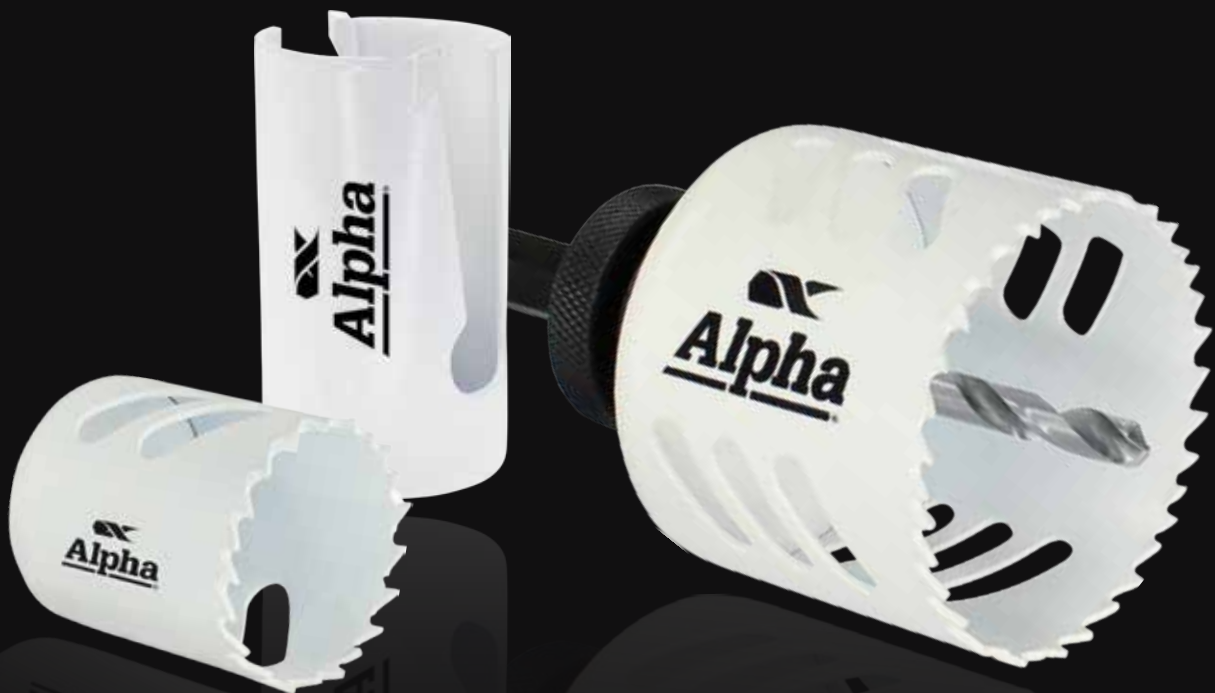

HEAVY DUTY stays sharper longer



- Steel
- Stainless Steel
- Cast Iron
- Wood
- Plastic

WHITE POINTER 8% COBALT

BI-METAL HOLESAW

Engineered for heavy duty industrial applications and smooth accurate cuts

MULTI PURPOSE



- Cement Sheet
- Wood
- Plastic
- Plasterboard
- Ceramic
- Aluminium

TCT HOLESAW

Fast and clean multi-purpose cutting

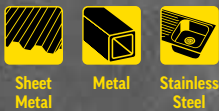

**HSS HOLE CUTTER
WITH ARBOR**

2mm cutting depth
10x longer working life than
standard Bi-Metal holesaws
when cutting sheet metal

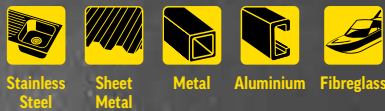

**TCT HOLE CUTTER
WITH ARBOR**

5mm cutting depth in stainless steel
when used with a battery drill
20mm cutting depth in stainless steel
when using a low-speed drill press
10x longer working life than
standard Bi-Metal holesaws
when cutting sheet metal

Holesaws & Hole Cutters

Alpha is excited to present an extended range of high-quality holesaws and hole cutters. Our new White Pointer Bi-Metal holesaw has been engineered for superior heavy duty cutting performance and accuracy.

WHITE POINTER

8%
COBALT

BI-METAL HOLESAWS

Ideal for: Steel, stainless steel, cast iron,
non-ferrous metal, wood and plastic

**HEAVY
DUTY** stays
sharper
longer



Multiple ejection slots
for rapid removal of thick
and thin plugs (HSV40
and over)

Unique multiple grinding technology
for faster cutting and longer life

4/6 variable tooth configuration
reduces vibration for a smooth,
accurate cut

Bi-Metal construction with 8% cobalt
welded teeth for extended life in
industrial applications



14 to 24mm
1 ejection slot to
maintain in-use
durability



25 to 38mm
2 ejection slots for maximum
plug removal while
maintaining in-use durability



40mm and over
3 ejection slots for
rapid removal of thick
and thin plugs



International standard thread pattern
accepts all common arbors

WHITE POINTER

8% COBALT

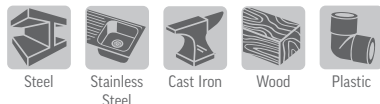

HEAVY DUTY stays sharper longer



Bi-Metal Holesaws

- Multiple ejection slots for rapid removal of thick and thin plugs (HSV40 and over)
- 4/6 variable tooth configuration reduces vibration for a smooth, accurate cut
- Unique multiple grinding technology for faster cutting and longer life
- Bi-Metal construction with 8% cobalt welded teeth for extended life in industrial applications
- International standard thread pattern accepts all common arbors

Holesaw sizes up to 38mm dia: 38mm cutting depth
Holesaw sizes 40mm dia and up: 48mm cutting depth

Ideal for: Steel, stainless steel, cast iron, non-ferrous metal, wood and plastic

Alpha CDT cutting fluid (code: ATL005) is recommended for increased life when drilling steel.

CARDED



CARDED - 1 PCE
Supplied in hangable or free-standing card

WHITE POINTER BI-METAL

WHITE POINTER BI-METAL				Suitable arbor					Suitable arbor
Ø mm	Ø inches	no. of ejection slots	CARDED 1 PCE		Ø mm	Ø inches	no. of ejection slots	CARDED 1 PCE	
14	9/16	1	HSV14	ARB-1 see page 131	65	2 9/16	3	HSV65	ARB-2 & ARB-3 see page 131
16	5/8	1	HSV16		67	2 5/8	3	HSV67	
17	11/16	1	HSV17		68	2 21/32	3	HSV68	
19	3/4	1	HSV19		70	2 3/4	3	HSV70	
20	25/32	1	HSV20		73	2 7/8	3	HSV73	
21	13/16	1	HSV21		75	2 15/16	3	HSV75	
22	7/8	1	HSV22		76	3	3	HSV76	
24	15/16	1	HSV24		79	3 1/8	3	HSV79	
25	1	2	HSV25		83	3 1/4	3	HSV83	
27	1 1/16	2	HSV27		86	3 3/8	3	HSV86	
29	1 1/8	2	HSV29		89	3 1/2	3	HSV89	
30	1 3/16	2	HSV30		92	3 5/8	3	HSV92	
32	1 1/4	2	HSV32		95	3 3/4	3	HSV95	
33	1 5/16	2	HSV33		98	3 7/8	3	HSV98	
35	1 3/8	2	HSV35	100	3 15/16	3	HSV100		
37	1 7/16	2	HSV37	102	4	3	HSV102		
38	1 1/2	2	HSV38	105	4 1/8	3	HSV105		
40	1 9/16	3	HSV40	108	4 1/4	3	HSV108		
41	1 5/8	3	HSV41	111	4 3/8	3	HSV111		
43	1 11/16	3	HSV43	114	4 1/2	3	HSV114		
44	1 3/4	3	HSV44	121	4 3/4	3	HSV121		
45	1 25/32	3	HSV45	127	5	3	HSV127		
46	1 13/16	3	HSV46	140	5 1/2	3	HSV140		
48	1 7/8	3	HSV48	146	5 3/4	3	HSV146		
50	1 31/32	3	HSV50	152	6	3	HSV152		
51	2	3	HSV51	160	6 5/16	3	HSV160		
52	2 1/16	3	HSV52	168	6 5/16	3	HSV168		
54	2 1/8	3	HSV54	177	7	3	HSV177		
55	2 5/32	3	HSV55	185	7 1/4	3	HSV185		
57	2 1/4	3	HSV57	200	7 7/8	3	HSV200		
59	2 5/16	3	HSV59	210	8 1/4	3	HSV210		
60	2 3/8	3	HSV60	250	9 13/16	3	HSV250		
64	2 1/2	3	HSV64						

WHITE POINTER

8% COBALT

HOLESAW KITS



Re-designed cases

New

DESIGNED FOR EASE OF USE AND LONG-LIFE

- Strong ABS plastic case with aluminium latches, withstands tough jobsite conditions
- Flexible and easy to find product layout: Holesaws are laid out for quick and easy selection, and smaller sizes do not need to be removed from the arbor for fast pack up
- Ergonomic comfort grip handle
- Unique hinge design allows the lid to open wide without overbalancing

DESIGNED TO MAXIMISE INSTORE SALES

- Strong on-shelf presence
- Kit type and contents clearly portrayed to enhance consumer self-service
- Four types available to target specific trades, complete with the required holesaw sizes, arbors, pilot drills and additional required products
- Stackable box for easy storage



MERCHANDISERS

Available for 11 and 13 piece kits

- High impact sales graphics
- Easy access pull out stock
- Clearly displays kit type
- 3 per box

Size: W 295 x D 327 x H 290mm

	Kit Type	Kit Contents	CODE
	<p>Electrician's Kit 11 PCE</p>	<p>7 x Holesaws: 16, 20, 25, 32, 40, 51 & 64mm Spade bit (TurboBORE): 25mm (TS08-25) Small arbor with pilot drill: suits 14 – 30mm holesaws (ARB-1) Large arbor with pilot drill: suits 32 – 250mm holesaws (ARB-2) Pilot drill: 3 1/4" (PLD-1) Adaptor (ARB-ADP)</p> <p>ALSO AVAILABLE Alternative holesaw size selection: 20, 25, 32, 40, 51, 70 & 92mm</p>	<p>HSKELW11</p> <p>HSKELW11L</p>
	<p>Ultimate Electrician's Kit 19 PCE</p>	<p>14 x Holesaws: 16, 20, 22, 25, 29, 32, 40, 44, 51, 54, 64, 70, 73 & 92mm Hex drill set (15 PCE): 1.5 – 6.5mm (9QRM-SET15) Spade bit (TurboBORE): 25mm (TS08-25) Small arbor with pilot drill: suits 14 – 30mm holesaws (ARB-1) Large arbor with pilot drill: suits 32 – 250mm holesaws (ARB-2) Pilot drill: 3 1/4" (PLD-1) Adaptor (ARB-ADP)</p>	<p>HSKELW19</p>
	<p>Tradie's Kit 13 PCE</p>	<p>10 x Holesaws: 16, 20, 22, 25, 32, 40, 51, 54, 64 & 92mm Small arbor with pilot drill: suits 14 – 30mm holesaws (ARB-1) Large arbor with pilot drill: suits 32 – 250mm holesaws (ARB-2) Pilot Drill: 3 1/4" (PLD-1) Adaptor (ARB-ADP)</p>	<p>HSKTRW13</p>
	<p>Ultimate Tradie's Kit 21 PCE</p>	<p>17 x Holesaws: 16, 20, 22, 25, 29, 32, 35, 38, 40, 51, 54, 60, 64, 70, 76, 92 & 114mm Hex drill set (15 PCE): 1.5 – 6.5mm (9QRM-SET15) Small arbor with pilot drill: suits 14 – 30mm holesaws (ARB-1) Large arbor with pilot drill: suits 32 – 250mm holesaws (ARB-2) Pilot drill: 3 1/4" (PLD-1) Adaptor (ARB-ADP)</p>	<p>HSKTRW21</p>
	<p>Plumber's Kit 11 PCE</p>	<p>7 x Holesaws: 19, 22, 30, 35, 44, 51 & 57mm Spade Bit (TurboBORE): 16mm (TS08-16) Small arbor with pilot drill: suits 14 – 30mm holesaws (ARB-1) Large arbor with pilot drill: suits 32 – 250mm holesaws (ARB-2) Pilot drill: 3 1/4" (PLD-1) Adaptor (ARB-ADP)</p>	<p>HSKPLW11</p>
	<p>Ultimate Plumber's Kit 16 PCE</p>	<p>11 x Holesaws: 19, 22, 25, 30, 35, 44, 51, 57, 73, 92 & 114mm Hex drill set (15 PCE): 1.5 – 6.5mm (9QRM-SET15) Auger bit (4 Cutter): 16mm (TS4C-16) Small arbor with pilot drill: suits 14 – 30mm holesaws (ARB-1) Large arbor with pilot drill: suits 32 – 250mm holesaws (ARB-2) Pilot drill: 3 1/4" (PLD-1) Adaptor (ARB-ADP)</p>	<p>HSKPLW16</p>
	<p>Locksmith's Kit 11 PCE</p>	<p>7 x Holesaws: 22, 25, 32, 38, 44, 54 & 60mm Spade bit (TurboBORE): 25mm (TS08-25) Small arbor with pilot drill: suits 14 – 30mm holesaws (ARB-1) Large arbor with pilot drill: suits 32 – 250mm holesaws (ARB-2) Pilot drill: 3 1/4" (PLD-1) Adaptor (ARB-ADP)</p>	<p>HSKLOW11</p>

Multi-Purpose TCT Holesaws



MULTI-PURPOSE **10x** LIFE TCT Holesaws

Cuts up to 5 times faster than Bi-Metal holesaws

Ideal for: Cement sheet, wood, aluminium, plasterboard, ceramic tiles and plastic

*Lasts 10 times longer than Bi-Metal holesaws when cutting cement sheet, wood, aluminium, plasterboard, ceramic and plastic

- Premium quality brazed tungsten carbide teeth for fast and clean cutting
 - Deep slots for easy plug removal and fast chip clearance
 - Heavy duty backing plate for increased rigidity
- 60mm cutting depth



CARDED



BOXED - 1 PCE
Supplied in hangable or free-standing box

TCT			Suitable arbor	TCT			Suitable arbor
Ø mm	Ø inches	CODE 1 PCE		Ø mm	Ø inches	CODE 1 PCE	
16	5/8	HSTCT16	ARB-4 see page 131	67	2 5/8	HSTCT67	ARB-5 see page 131
20	2 5/32	HSTCT20		68	2 21/32	HSTCT68	
22	7/8	HSTCT22		70	2 3/4	HSTCT70	
25	1	HSTCT25		73	2 7/8	HSTCT73	
27	1 1/16	HSTCT27		76	3	HSTCT76	
30	1 3/16	HSTCT30		80	3 1/8	HSTCT80	
32	1 1/4	HSTCT32		82	3 7/32	HSTCT82	
35	1 3/8	HSTCT35		86	3 3/8	HSTCT86	
38	1 1/2	HSTCT38		89	3 1/2	HSTCT89	
40	1 9/16	HSTCT40		92	3 5/8	HSTCT92	
44	1 3/4	HSTCT44	102	4	HSTCT102		
50	1 31/32	HSTCT50	114	4 1/2	HSTCT114		
51	2	HSTCT51	125	5	HSTCT125		
54	2 1/8	HSTCT54	140	5 1/2	HSTCT140		
57	2 1/4	HSTCT57	152	6	HSTCT152		
60	2 3/8	HSTCT60					
64	2 1/2	HSTCT64					

MULTI-PURPOSE TCT Holesaw Kits

Multi-Purpose TCT Holesaw Kits



Tradie's
TCT Holesaw Kit
16 Piece Set



Electrician's
TCT Holesaw Kit
12 Piece Set



Plumber's
TCT Holesaw Kit
8 Piece Set



TCT Kit Type	Kit Contents	CODE
Electrician's Kit 12 PCE	8 x Holesaws: 20, 22, 25, 32, 40, 51, 70 & 92mm Small arbor with TCT pilot drill: suits 14 – 30mm holesaws Large arbor with TCT pilot drill: suits 32 – 250mm holesaws TCT pilot drill: 6.5 x 114mm (PLD-4) Adaptor (ARB-ADP)	HSTCKEL12
Tradie's Kit 16 PCE	11 x Holesaws: 16, 20, 22, 25, 32, 35, 38, 44, 51, 54 & 64mm Small arbor with TCT pilot drill: suits 14 – 30mm holesaws Large arbor with TCT pilot drill: suits 32 – 250mm holesaws 2 x TCT pilot drills: 6.5 x 89mm (PLD-3) & 6.5 x 114mm (PLD-4) Adaptor (ARB-ADP)	HSTCKTR16
Plumber's Kit 8 PCE	6 x Holesaws: 22, 25, 32, 44, 51 & 54mm Small arbor with TCT pilot drill: suits 14 – 30mm holesaws Large arbor with TCT pilot drill: suits 32 – 250mm holesaws	HSTCKPL8
Joiner's Kit* 7 PCE	5 x Holesaws: 35, 54, 60, 68 & 80mm Large arbor with TCT pilot drill: suits 32 – 250mm holesaws HSS pilot drill: 6.35 x 114mm (PLD-2)	HSTCKJ7

*Not pictured

BRISTOL

tool works

BI-METAL Holesaw Kits



Steel Wood Plastic

Quality products for the discerning tradesman or handyman

- M42 Bi-Metal cutting edge
- 4/6 variable tooth geometry



- Quality presentation
- Bold colouring
- Attractive packaging

TCT Kit Type	Kit Contents	CODE
Electrician's Kit 9 PCE	7 x Holesaws: 20, 22, 25, 32, 40, 51 & 70mm Small arbor with pilot drill: suits 14 - 30mm holesaws Large arbor with pilot drill: suits 32 - 250mm holesaws Adaptor (ARB-ADP)	BTWEL9
Tradie's Kit 12 PCE	10 x Holesaws: 16, 19, 22, 29, 35, 38, 44, 51, 54 & 64mm Small arbor with pilot drill: suits 14 - 30mm holesaws Large arbor with pilot drill: suits 32 - 250mm holesaws Adaptor (ARB-ADP)	BTWTR12
Plumber's Kit 9 PCE	7 x Holesaws: 19, 22, 29, 38, 44, 51 & 57mm Small arbor with pilot drill: suits 14 - 30mm holesaws Large arbor with pilot drill: suits 32 - 250mm holesaws Adaptor (ARB-ADP)	BTWPL9

Arbors

BI-METAL HOLESAW ARBORS – CARDED *includes 1 arbor & 1 HSS pilot drill*

Suits	Arbor Shank	Arbor Type	Pilot Drill	CARDED
14 – 30mm	11/32" quick change shank for 10mm (3/8") chuck		HSS – 6.35 x 89mm	ARB-1
	SDS plus		HSS – 6.35 x 89mm	ARBSP-1
32 – 250mm	7/16" hex shank for 13mm (1/2") chuck	heavy duty screw-up design	HSS – 6.35 x 114mm	ARB-2
	11/32" quick change shank for 10mm (3/8") chuck	quick release mechanism	HSS – 6.35 x 89mm	ARB-3

BI-METAL & TCT ARBOR SETS – CARDED *includes 1 arbor & 2 pilot drills*

Suits	Arbor Shank	Arbor Type	Pilot Drills	CARDED
14 – 30mm	11/32" quick change shank for 10mm (3/8") chuck		HSS – 6.35 x 89mm TCT – 6.5 x 89mm	ARB-4
32 – 250mm	7/16" hex shank for 13mm (1/2") chuck	heavy duty screw-up design	HSS – 6.35 x 114mm TCT – 6.5 x 114mm	ARB-5



CARDED ARBORS
1 arbor and 1 pilot drill
Supplied in hangable card

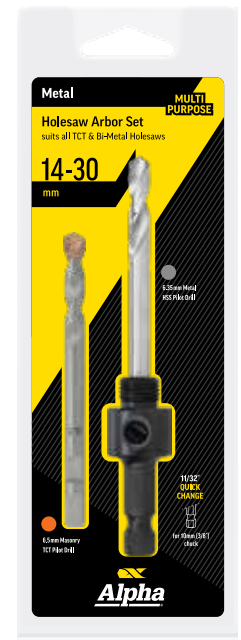

CARDED ARBOR SETS
1 arbor and 2 pilot drills
Supplied in hangable card

Pilot Drills

HSS – CARDED

Suits	Ø mm	CARDED
All Holesaws <i>Ideal for steel, wood & plastic</i>	6.35 x 89mm	PLD-1
	6.35 x 114mm	PLD-2

TCT – CARDED

Suits	Ø mm	CARDED
TCT Holesaws <i>Ideal for fibre cement sheet, ceramic, wall tiles & soft stone</i>	6.5 x 89mm	PLD-3
	6.5 x 114mm	PLD-4



CARDED – 1 PCE
Supplied in hangable card

Adaptor

Adaptor to convert small to large arbors
Supplied on individual card

Code: ARB-ADP



New

PRO LOCK

THE QUICK CHANGE HOLESAW SYSTEM

Work faster and smarter with the unique Alpha Pro Lock arbor system.

Reduce holesaw changes to seconds and eliminate jamming, thanks to the quick release design.

Arbor suits all major brands of TCT and Bi-Metal holesaws (14 - 198mm)

HSS pilot drill with improved chip extraction

Adaptors with positive, rigid locking mechanism for clean, accurate holes

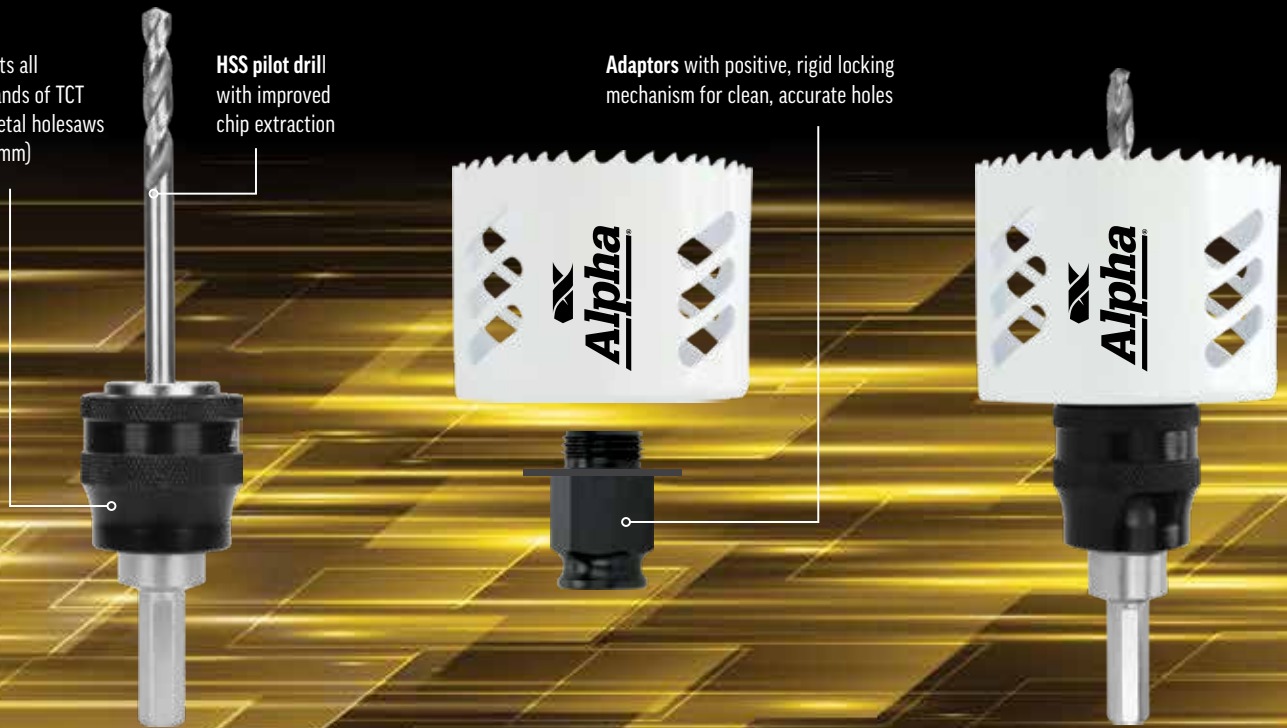

PRO LOCK

THE QUICK CHANGE HOLESAW SYSTEM



Pro Lock Kit
Suits all major brands of TCT & Bi-Metal holesaws (14 - 198mm)

KIT CONTENTS

Arbor: Suits 14 - 198mm holesaws

Pilot drill: 124 x 6.35mm (1/4")
(replacement code PLD-7)

Small adaptor: suits holesaws 14 - 30mm
(replacement code ADP-1QC)

Large adaptor: Suits holesaws 32 - 198mm
(replacement code ADP-2QC)

Hex Key

Code: ARB-2QCK

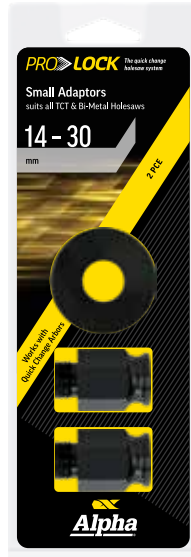

Small Adaptors
2 PCE
Suits holesaws 14 - 30mm

Code: ADP-1QC

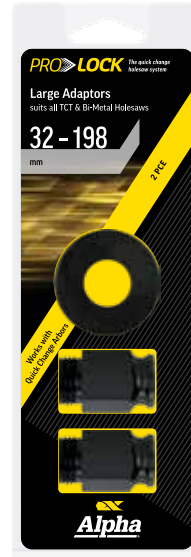

Large Adaptors
2 PCE
Suits holesaws 32 - 198mm

Code: ADP-2QC



HSS Pilot Drill
1 PCE
124 x 6.35mm (1/4")

Code: PLD-7

Attaching the adaptor and quick change arbor

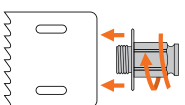

Place washer on adaptor and screw into holesaw

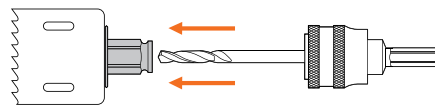

Attach the quick change arbor

Removing the Quick Change Arbor

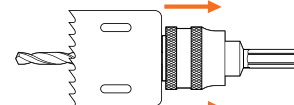

Pull back sleeve to release holesaw

HSS

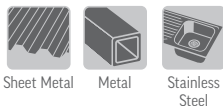

BULK - 1 PCE
Supplied in hangable plastic pack

Replacement Pilot Drills

5.0 x 45mm suits HSS Hole Cutters 15 – 25mm **Code: PLD-8**

6.0 x 45mm suits HSS Hole Cutters 28 – 102mm **Code: PLD-5**



HSS Thin Sheet Hole Cutter with Arbor

Fast and clean cutting, suitable for drilling sheet metal, steel pipe, stainless steel, aluminium and fibreglass reinforced synthetic materials

- 2mm cutting depth
- 10x longer working life than standard Bi-Metal holesaws when cutting sheet metal
- Accurate, fast and clean holes
- Ejector spring for disc ejection
- Replaceable pilot drill
- Complete with arbor
- Fits standard chucks

BULK

METRIC			
Ø mm	Ø inches	Pilot drill	CODE 1 PCE
15	9/16	PLD-8	HCS15
16	5/8	PLD-8	HCS16
18	11/16	PLD-8	HCS18
19	3/4	PLD-8	HCS19
20	25/32	PLD-8	HCS20
22	7/8	PLD-8	HCS22
25	1	PLD-8	HCS25
28	1 1/8	PLD-5	HCS28
30	1 3/16	PLD-5	HCS30
32	1 1/4	PLD-5	HCS32
35	1 3/8	PLD-5	HCS35
38	1 1/2	PLD-5	HCS38
40	1 9/16	PLD-5	HCS40
50	1 31/32	PLD-5	HCS50
60	2 3/8	PLD-5	HCS60
63	2 1/4	PLD-5	HCS63
65	2 7/16	PLD-5	HCS65
76	3	PLD-5	HCS76
87	3 7/16	PLD-5	HCS87
92	3 5/8	PLD-5	HCS92
102	4	PLD-5	HCS102

HSS Hole Cutter Kit

9 PCE

- CONTAINS:**
- 7 x HSS Hole cutters with arbors: 16, 20, 22, 25, 32, 40, & 50mm
 - 2 x Spare pilot drills
 - 2 x Hex keys

Code: HCSS16-50

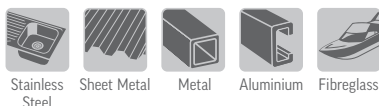

TCT Hole Cutter with Arbor

Fast and clean cutting, suitable for drilling sheet metal, steel pipe, stainless steel, aluminium and fibreglass reinforced synthetic materials.

- 5mm cutting depth in stainless steel when used with a battery drill
- 20mm cutting depth in stainless steel when using a low-speed drill press
- 20x longer working life than standard Bi-Metal holesaw when cutting sheet metal
- Premium quality TCT teeth for clean, accurate holes
- Ejector spring for disc ejection
- Replaceable pilot drill
- Complete with arbor
- Fits standard chucks



BULK - 1 PCE
Supplied in hangable plastic pack

Hole Cutter ø mm	Material	Max Cutting Thickness	Max RPM
16mm	Stainless steel tube	3mm	700
	Stainless steel plate	10mm	200
20mm	Stainless steel tube	3mm	500
	Stainless steel plate	10mm	170
25mm	Stainless steel tube	3mm	400
	Stainless steel plate	10mm	140

TRADIE TIP
cutting speeds

BULK

METRIC			
ø mm	ø inches	Pilot drill	CODE 1 PCE
16	5/8	PLD-6	HCSTCT16
18	11/16	PLD-6	HCSTCT18
19	3/4	PLD-6	HCSTCT19
20	25/32	PLD-6	HCSTCT20
22	7/8	PLD-6	HCSTCT22
25	1	PLD-6	HCSTCT25
26	1	PLD-6	HCSTCT26
28	1 1/8	PLD-6	HCSTCT28
30	1 3/16	PLD-6	HCSTCT30
32	1 1/4	PLD-6	HCSTCT32
35	1 3/8	PLD-6	HCSTCT35
38	1 1/2	PLD-6	HCSTCT38
40	1 9/16	PLD-6	HCSTCT40
45	1 25/32	PLD-6	HCSTCT45
50	1 31/32	PLD-6	HCSTCT50
60	2 3/8	PLD-6	HCSTCT60
65	2 3/8	PLD-6	HCSTCT65

Replacement spring suits TCT Hole Cutters

Code: PLD-6SPRING

Replacement Pilot Drill 6.0 x 60mm suits TCT Hole Cutters

Code: PLD-6



TCT Hole Cutter Kit 8 PCE

- CONTAINS:**
- 6 x TCT Hole cutters with arbors: 16, 20, 22, 25, 32 and 40mm
 - 2 x Spare pilot drills
 - 2 x Hex keys

Code: HCSTCTS16-40



RIPPA

TIGER
13-180mm

Alpha

13-180mm
14
15
16
17
18

SLICER

MEDIUM METAL
210mm

Alpha

14
15
16
17
18

Reciprocating New Blades

DESTRUCTOR - Demolition Blades	
Wood & Nails	139
Metal	140
Metal & Timber	142
DESTRUCTOR SET	143
RIPPA - Timber Blades	145
SLICER - Metal Blades	147
GENERAL PURPOSE SET	149



DEMOLITION

DESTRUCTOR

Built stronger for extended life

10x LIFE

Super heavy duty blade lasts up to 10x longer *than standard recip blades

ICE HARDENED

for ultimate toughness & long life



PROSHIELD
technology

Premium non-stick coating for smooth, effortless cutting

8% COBALT

for flexibility & break resistance

- Tall and strong blade ensures fast, straight cuts
- Precision ground and set teeth for fast cutting without clogging



Milled & Wavy Set

The cut takes place on the entire surface of the tooth, producing finer, straight cuts in timber and metal.



Available in both bulk and carded



Available in both bulk and carded



Available in both bulk and carded

Wood & Nails

Ideal for: Softwood, hardwood, wood with nails and plastic

- Strengthened and reinforced tooth design guards against fracture from nails
- Tapered end design for plunge cutting

Metal

Ideal for: Metal, wood with nails and plastic

Available in: 10 TPI for **THICK METAL**
14 TPI for **MEDIUM METAL**
18 TPI for **MED-THIN METAL**

Metal & Timber

Ideal for: Wood with nails, metal, stainless steel, non-ferrous metal, aluminum, cast iron and pipes

- Tapered end design for plunge cutting

DEMOLITION WOOD & NAILS DESTRUCTOR Recip Blade

'Destructor' blades are engineered for the most demanding heavy duty demolition jobs.

Ideal for: Softwood, hardwood, wood with nails and plastic

- Super heavy duty blade lasts up to 10x longer than standard recip blades
- Ice hardened for ultimate toughness and long life
- ProShield technology for smooth, effortless cutting
- Cobalt Bi-Metal HSS for flexibility and break resistance
- Strengthened and reinforced tooth design guards against fracture from nails
- Tall and strong blade ensures fast, straight cuts
- Tapered end design for plunge cutting
- Precision ground and set teeth for fast cutting without clogging



RDDW – Wood & Nails DESTRUCTOR Reciprocating Blade, 5 TPI

5 TPI	WOOD & NAILS					DEMOLITION	
10x LIFE	ICE HARDENED	PROSHIELD technology	8% COBALT	NAIL ARMOR	CUT TYPE Rough Plunge Straight Fast	CUT THICKNESS – Wood & nails 150 OAL blade: 3 – 100mm 230 OAL blade: 3 – 180mm 230 OAL blade: 3 – 250mm	 Wood & Nails Plastic

CARDED & BULK								
OAL mm	Tooth Pitch	Cut Length mm	Blade Thickness	Blade Height mm	Blade Material	CARDED 2 per card	CARDED 5 per card	BULK 25 per pack
150	5 TPI	127	1.6mm (0.062")	22	8% Cobalt Bi-Metal	RDDW1505-2	RDDW1505-5	RDDW1505-25
230	5 TPI	207	1.6mm (0.062")	22	8% Cobalt Bi-Metal	RDDW2305-2	RDDW2305-5	RDDW2305-25
300	5 TPI	277	1.6mm (0.062")	22	8% Cobalt Bi-Metal	RDDW3005-2	RDDW3005-5	RDDW3005-25

CARDED – 2 PCE & 5 PACK Supplied in hangable card | BULK – 25 PACK Supplied in plastic pack

Blade shown at 75% of actual size

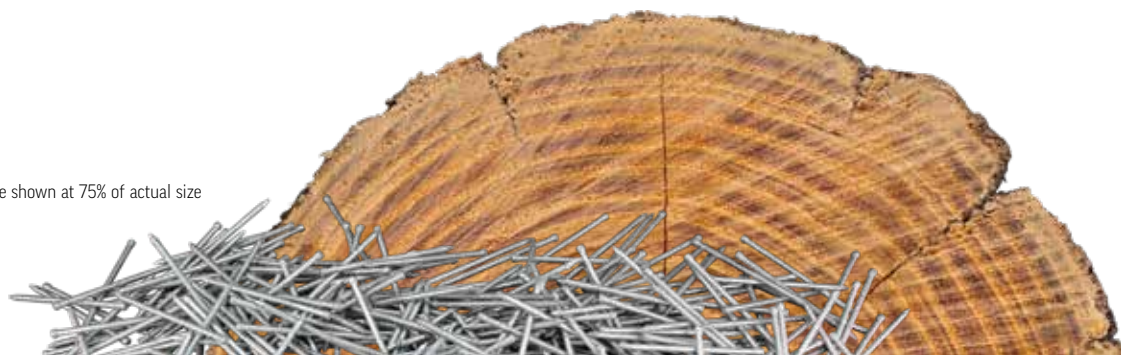

DESTRUCTOR – Metal Demolition Blades

DEMOLITION METAL
DESTRUCTOR Recip Blades

'Destructor' blades are engineered for the most demanding heavy duty demolition jobs.

Ideal for: Metal, wood with nails and plastic

- Super heavy duty blade lasts up to 10x longer than standard recip blades
- Ice hardened for ultimate toughness and long life
- ProShield technology for smooth, effortless cutting
- Cobalt Bi-Metal HSS for flexibility and break resistance
- Tall and strong blade ensures fast, straight cuts
- Precision ground and set teeth for fast cutting without clogging



RDDM – Metal DESTRUCTOR Reciprocating Blade, 10 TPI

10 TPI	THICK METAL									
10x LIFE	ICE HARDENED	PROSHIELD technology	8% COBALT	CUT TYPE Rough Straight Fast	CUT THICKNESS Metal: 3 - 12mm Stainless steel: 2.5 - 4mm Plastic: 3 - 12mm	Wood & nails (150 OAL blade): 3 - 100mm Wood & nails (230 OAL blade): 3 - 180mm	Metal	Stainless Steel	Wood & Nails	Plastic



CARDED & BULK							CARDED	CARDED	BULK
OAL mm	Tooth Pitch	Cut Length mm	Blade Thickness	Blade Height mm	Blade Material		2 per card	5 per card	25 per pack
150	10 TPI	127	1.1mm (0.043")	25	8% Cobalt Bi-Metal		RDDM15010-2	RDDM15010-5	RDDM15010-25
230	10 TPI	207	1.1mm (0.043")	25	8% Cobalt Bi-Metal		RDDM23010-2	RDDM23010-5	RDDM23010-25

CARDED - 2 PCE & 5 PACK Supplied in hangable card | BULK - 25 PACK Supplied in plastic pack



Blade shown at 75% of actual size

DESTRUCTOR – Metal Demolition Blades



RDDM – Metal DESTRUCTOR Reciprocating Blade, 14 TPI

14 TPI	MEDIUM METAL		
	CUT TYPE Rough Straight Fast	CUT THICKNESS Metal: 2 – 8mm Stainless steel: 2.5 – 3mm Plastic: 2 – 8mm Wood & nails (150 OAL blade): 3 – 100mm Wood & nails (230 OAL blade): 3 – 180mm	



CARDED & BULK								
OAL mm	Tooth Pitch	Cut Length mm	Blade Thickness	Blade Height mm	Blade Material	CARDED 2 per card	CARDED 5 per card	BULK 25 per pack
150	14 TPI	127	1.1mm (0.043")	25	8% Cobalt Bi-Metal	RDDM15014-2	RDDM15014-5	RDDM15014-25
230	14 TPI	207	1.1mm (0.043")	25	8% Cobalt Bi-Metal	RDDM23014-2	RDDM23014-5	RDDM23014-25

CARDED – 2 PCE & 5 PACK Supplied in hangable card | BULK – 25 PACK Supplied in plastic pack



RDDM – Metal DESTRUCTOR Reciprocating Blade, 18 TPI

18 TPI	MED-THIN METAL		
	CUT TYPE Clean Straight Fast	CUT THICKNESS Metal: 1.5 – 3mm Stainless steel: 1.5 – 2mm Plastic: 1.5 – 3mm Wood & nails (150 OAL blade): 3 – 100mm Wood & nails (230 OAL blade): 3 – 180mm Wood & nails (300 OAL blade): 3 – 250mm	



CARDED & BULK								
OAL mm	Tooth Pitch	Cut Length mm	Blade Thickness	Blade Height mm	Blade Material	CARDED 2 per card	CARDED 5 per card	BULK 25 per pack
150	18 TPI	127	1.1mm (0.043")	25	8% Cobalt Bi-Metal	RDDM15018-2	RDDM15018-5	RDDM15018-25
230	18 TPI	207	1.1mm (0.043")	25	8% Cobalt Bi-Metal	RDDM23018-2	RDDM23018-5	RDDM23018-25
300	18 TPI	277	1.1mm (0.043")	25	8% Cobalt Bi-Metal	RDDM30018-2	RDDM30018-5	RDDM30018-25

CARDED – 2 PCE & 5 PACK Supplied in hangable card | BULK – 25 PACK Supplied in plastic pack

Blades shown at 75% of actual size

DESTRUCTOR – Metal & Timber Demolition Blades

DEMOLITION METAL & TIMBER
DESTRUCTOR Recip Blade

'Destructor' blades are engineered for the most demanding heavy duty demolition jobs.

Ideal for: Wood with nails, metal, non-ferrous metal, aluminium, cast iron and pipes.

- Super heavy duty blade lasts up to 10x longer than standard recip blades
- Ice hardened for ultimate toughness and long life
- ProShield technology for smooth, effortless cutting
- Cobalt Bi-Metal HSS for flexibility and break resistance
- Tall and strong blade ensures fast, straight cuts
- Tapered end design for plunge cutting
- Precision ground and set teeth for fast cutting without clogging



RDDM – Metal & Timber DESTRUCTOR Reciprocating Blade, 8 TPI

8 TPI		METAL & TIMBER				DEMOLITION					
10x LIFE	ICE HARDENED	PROSHIELD technology	8% COBALT	CUT TYPE	CUT THICKNESS						
				Rough Plunge Straight Fast	Metal: 3 – 12mm Cast iron: 3 – 12mm Plastic: 3 – 12mm	Wood & nails (150 OAL blade): 6 – 100mm Wood & nails (230 OAL blade): 6 – 180mm Wood & nails (230 OAL blade): 6 – 250mm					

CARDED & BULK

OAL mm	Tooth Pitch	Cut Length mm	Blade Thickness	Blade Height mm	Blade Material	CARDED 2 per card	CARDED 5 per card	BULK 25 per pack
150	8 TPI	127	1.6mm (0.062")	22	8% Cobalt Bi-Metal	RDDM1508-2	RDDM1508-5	RDDM1508-25
230	8 TPI	207	1.6mm (0.062")	22	8% Cobalt Bi-Metal	RDDM2308-2	RDDM2308-5	RDDM2308-25
300	8 TPI	277	1.6mm (0.062")	22	8% Cobalt Bi-Metal	RDDM3008-2	RDDM3008-5	RDDM3008-25

CARDED – 2 PCE & 5 PACK Supplied in hangable card | BULK – 25 PACK Supplied in plastic pack

Blade shown at 75% of actual size



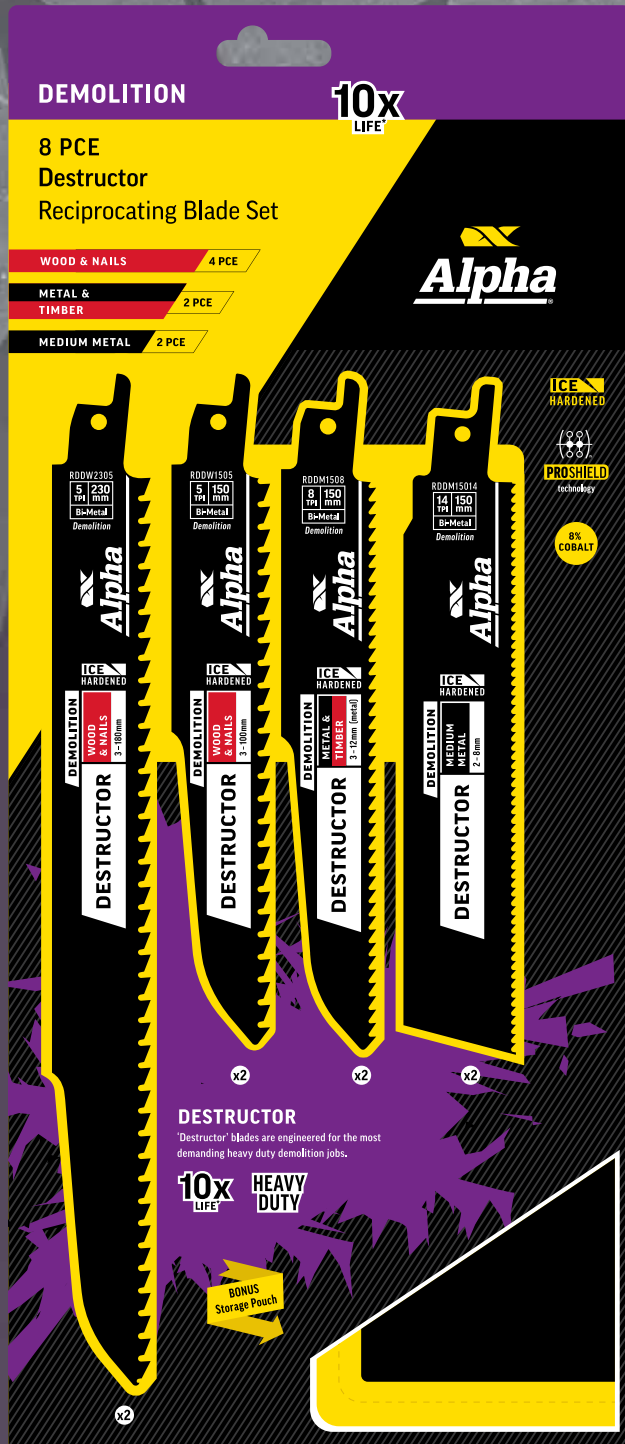

Available
December
2019

8 PCE DEMOLITION Set

CONTAINS:

8 Destructor Recip Blades

- 2 x Wood & Nails OAL 230 (RDDW2305)
- 2 x Wood & Nails OAL 150 (RDDW1505)
- 2 x Metal & Timber OAL 150 (RDDM1508)
- 2 x Medium Metal OAL 150 (RDDM15014)

Code: RDD-SET8

RIPPA – Timber Blades



RIPPA

Aggressive tooth design for **FAST** timber cutting

ICE HARDENED

for ultimate toughness & long life



PROSHIELD technology

Premium non-stick coating for smooth, effortless cutting

8% COBALT

for flexibility & break resistance

Timber

Ideal for: Fast and curved cuts in hardwoods, softwoods, plywood, chipboard and synthetic materials

- Aggressive precision ground and set teeth for fast cutting without clogging
- Tapered end design for plunge cutting
- Long tapered design provides optimum curved and fast cutting

Cross Ground & Tapered

The wood grain is cut by the slanted angle of the tooth, producing fast, cleaner cuts.

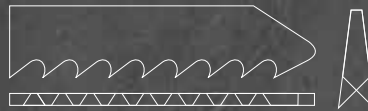

TIMBER RIPPA Recip Blade

Ideal for: Fast and curved cuts in hardwoods, softwoods, plywood, chipboard and synthetic materials

- Ice hardened for ultimate toughness and long life
- ProShield technology for smooth, effortless cutting
- Cobalt Bi-Metal HSS for flexibility and break resistance
- Aggressive precision ground and set teeth for fast cutting without clogging
- Tapered end design for plunge cutting
- Long tapered design provides optimum curved and fast cutting



RDRW – Timber RIPPA Reciprocating Blade, 5 TPI

5 TPI	TIMBER					
ICE HARDENED	PROSHIELD technology	8% COBALT	FAST timber cutting	CUT TYPE Rough Plunge Fast Curved	CUT THICKNESS – Wood & Nails 150 OAL blade: 15 – 100mm 230 OAL blade: 15 – 180mm 230 OAL blade: 15 – 250mm	Wood Plastic

CARDED							
OAL mm	Tooth Pitch	Cut Length mm	Blade Thickness	Blade Height mm	Blade Material	CARDED 2 per card	CARDED 5 per card
150	5 TPI	127	1.3mm (1/20")	19	8% Cobalt Bi-Metal	RDRW1505-2	RDRW1505-5
230	5 TPI	207	1.3mm (1/20")	19	8% Cobalt Bi-Metal	RDRW2305-2	RDRW2305-5
300	5 TPI	277	1.3mm (1/20")	19	8% Cobalt Bi-Metal	RDRW3005-2	RDRW3005-5

CARDED – 2 PCE & 5 PACK Supplied in hangable card

Blade shown at 75% of actual size



SLICER – Metal Blades



SLICER

Available in:

- 10 TPI for **THICK METAL**
- 14 TPI for **MEDIUM METAL**
- 18 TPI for **MED-THIN METAL**
- 24 TPI for **SHEET METAL**

**THIN
KERF**

for **FAST & FLEXIBLE** cuts

**ICE
HARDENED**

for ultimate toughness & long life



PROSHIELD
technology

Premium non-stick coating for smooth, effortless cutting

**8%
COBALT**

for flexibility & break resistance

Metal

Ideal for: Steel, stainless steel and non-ferrous metals

- Strong thin kerf blade for fast and flexible cuts

Milled & Wavy Set

The cut takes place on the entire surface of the tooth, producing finer, straight cuts in timber and metal.

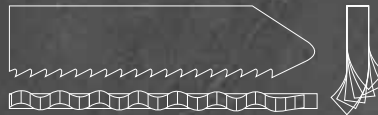

METAL SLICER Recip Blades

Ideal for: Steel, stainless steel and non-ferrous metals

- Ice hardened for ultimate toughness and long life
- ProShield technology for smooth, effortless cutting
- Cobalt Bi-Metal HSS for flexibility and break resistance
- Strong thin kerf blade for fast and flexible cuts



RDSM – Metal SLICER Reciprocating Blade, 10 TPI

10 TPI	THICK METAL						
				CUT TYPE Clean Straight Fast	CUT THICKNESS Metal: 3 – 12mm Stainless steel: 2.5 – 4mm		

CARDED							
OAL mm	Tooth Pitch	Cut Length mm	Blade Thickness	Blade Height mm	Blade Material	CARDED 2 per card	CARDED 5 per card
100	10 TPI	77	0.9mm (1/32")	19	8% Cobalt Bi-Metal	RDSM10010-2	RDSM10010-5
150	10 TPI	127	0.9mm (1/32")	19	8% Cobalt Bi-Metal	RDSM15010-2	RDSM15010-5
230	10 TPI	207	0.9mm (1/32")	19	8% Cobalt Bi-Metal	RDSM23010-2	RDSM23010-5
300	10 TPI	277	0.9mm (1/32")	19	8% Cobalt Bi-Metal	RDSM30010-2	RDSM30010-5

CARDED – 2 PCE & 5 PACK Supplied in hangable card



RDSM – Metal SLICER Reciprocating Blade, 14 TPI

14 TPI	MEDIUM METAL						
				CUT TYPE Clean Straight Fast	CUT THICKNESS Metal: 2 – 8mm Stainless steel: 2.5 – 3mm		

CARDED & BULK								
OAL mm	Tooth Pitch	Cut Length mm	Blade Thickness	Blade Height mm	Blade Material	CARDED 2 per card	CARDED 5 per card	BULK 25 per pack
150	14 TPI	127	0.9mm (1/32")	19	8% Cobalt Bi-Metal	RDSM15014-2	RDSM15014-5	
230	14 TPI	207	0.9mm (1/32")	19	8% Cobalt Bi-Metal	RDSM23014-2	RDSM23014-5	RDSM23014-25

CARDED – 2 PCE & 5 PACK Supplied in hangable card | BULK – 25 PACK Supplied in plastic pack



Blades shown at 75% of actual size

SLICER – Metal Blades



RDSM – Metal SLICER Reciprocating Blade, 18 TPI

18 TPI	MED-THIN METAL						
				CUT TYPE Clean Straight Fast	CUT THICKNESS Metal: 1.5 – 3mm Stainless steel: 1.5 – 2mm		

CARDED & BULK

OAL mm	Tooth Pitch	Cut Length mm	Blade Thickness	Blade Height mm	Blade Material	CARDED 2 per card	CARDED 5 per card	BULK 25 per pack
150	18 TPI	127	0.9mm (1/32")	19	8% Cobalt Bi-Metal	RDSM15018-2	RDSM15018-5	
230	18 TPI	207	0.9mm (1/32")	19	8% Cobalt Bi-Metal	RDSM23018-2	RDSM23018-5	RDSM23018-25
300	18 TPI	277	0.9mm (1/32")	19	8% Cobalt Bi-Metal	RDSM30018-2	RDSM30018-5	RDSM30018-25

CARDED – 2 PCE & 5 PACK Supplied in hangable card | BULK – 25 PACK Supplied in plastic pack

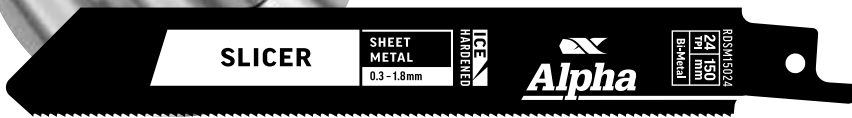
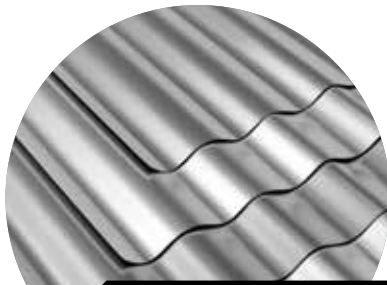

RDSM – Sheet Metal SLICER Reciprocating Blade, 24 TPI

24 TPI	SHEET METAL						
				CUT TYPE Clean Straight Fast	CUT THICKNESS Sheet metal: 0.3 – 1.8mm Stainless steel: 1.2 – 1.8mm		

CARDED

OAL mm	Tooth Pitch	Cut Length mm	Blade Thickness	Blade Height mm	Blade Material	CARDED 2 per card	CARDED 5 per card
150	24 TPI	127	0.9mm (1/32")	19	8% Cobalt Bi-Metal	RDSM15024-2	RDSM15024-5

CARDED – 2 PCE & 5 PACK Supplied in hangable card



Blades shown at 75% of actual size

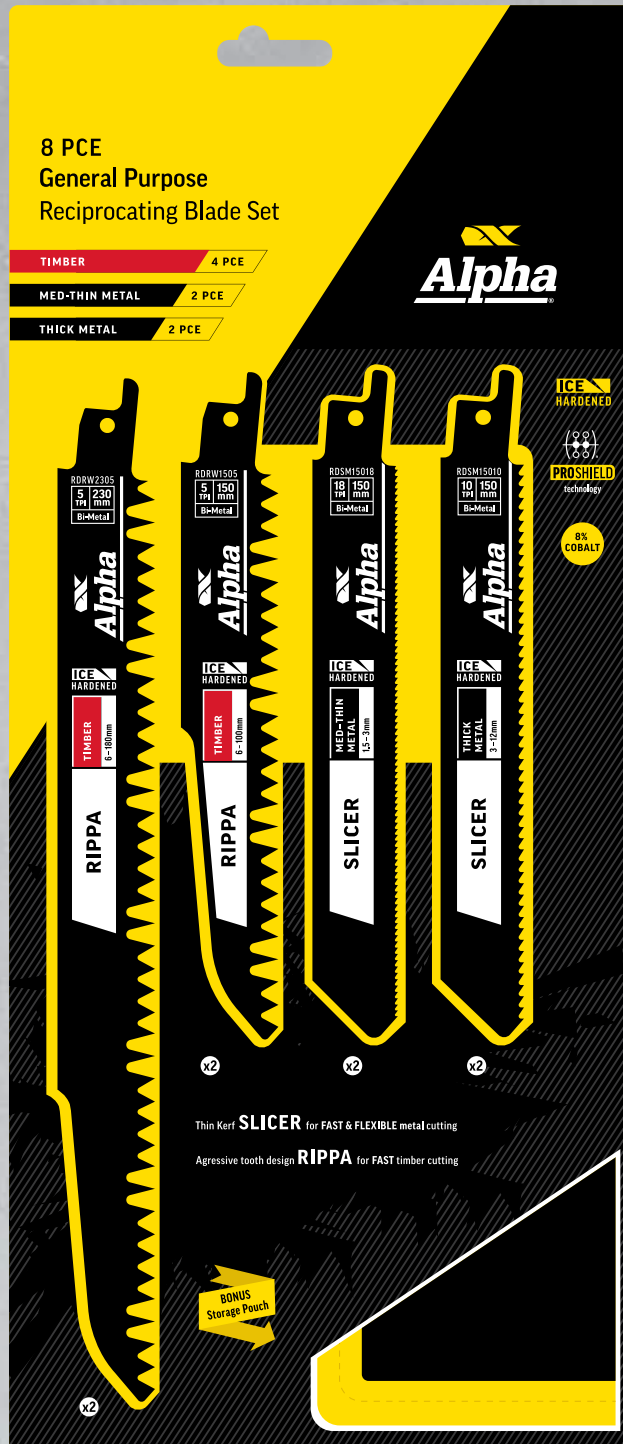

Available
December
2019

8 PCE General Purpose Set

CONTAINS:

8 General Purpose Recip Blades

- 2 x Timber OAL 230 (RDRW2305)
- 2 x Timber OAL 150 (RDRW1505)
- 2 x Med-thin OAL 150 (RDSM15018)
- 2 x Thick Metal OAL 150 (RDSM15010)

Code: RD-SET8



Multi-tool Blades



MULTI-MATERIAL

Nail Buster Bi-Metal Blade	155
Nail Buster Extreme Bi-Metal Blade	155
Surecut "Präzision" Bi-Metal Blade	156
HSS Segment Bi-Metal Blade	156

METAL

Metal Buster Tungsten Carbide Blade	157
-------------------------------------	-----

TIMBER & HARDWOOD

Fine Tooth Timber Blade	158
Coarse Tooth Timber Blade	158
Coarse Tooth Hardwood Blade	159
Japanese Tooth Timber Blade	160

SPECIALTY

Tungsten Carbide Segment Blade	160
--------------------------------	-----

SANDING

Sanding Pad Hook & Loop	161
Sanding Sheets	161

SETS & MERCHANDISERS

Sets	162
Merchandisers	164







Introducing Alpha Multi-tools

Alpha is pleased to announce a new versatile range of multi-tool blades.

The Alpha multi-tool product range offers superior blade technology to complete any task with ease and perfection. Packaged for maximum visual appeal, and to increase self service with clearly defined product information, the Alpha multi-tool range is guaranteed to be a consumer favourite.



Universal shank

Fits all common multi-tools

- AEG
- Black & Decker
- Bosch*
- Craftsman
- Dewalt
- Fein*
- Hitachi
- Makita
- Metabo
- Milwaukee
- Ozito
- Ridgid
- Rockwell
- Ryobi
- Skil
- SMART
- Stanley
- Worx

*Excludes tools with Starlock fittings



Product type and applications clearly displayed on packaging for easy consumer self service

	Wood	Wood & Nails	Timber Milling	Non Ferrous Metal	Sheetmetal	Car Panel	Plaster	Plasterboard	Fibreglass	Plastic	Grout Removal	Porous Concrete	Masonry
Nail Buster Bi-Metal Blade (32mm) page 155	✓	✓	✓	✓			✓	✓	✓	✓			
Nail Buster Extreme Bi-Metal Blade (32 & 44mm) page 155	✓	✓	✓	✓			✓	✓	✓	✓			
Surecut "Präzision" Bi-Metal Blade (65mm) page 156	✓	✓	✓	✓			✓	✓	✓	✓			
HSS Segment Bi-Metal Blade (90mm) page 156	✓	✓	✓	✓	✓	✓	✓	✓	✓	✓			
Metal Buster Tungsten Carbide Blade (35mm) page 157		✓		✓									
Fine Tooth Timber Blade (32mm) page 158	✓		✓				✓	✓		✓			
Coarse Tooth Timber Blade (32 & 63mm) page 158	✓		✓				✓	✓		✓			
Coarse Tooth Hardwood Blade (35 & 63mm) page 159	✓		✓				✓	✓		✓			
Coarse Tooth Hardwood Blade - Deep Cut (32mm) page 159		✓		✓			✓	✓			✓		
Japanese Tooth Timber Blade (32 & 63mm) page 160	✓		✓				✓	✓		✓			
Tungsten Carbide Segment Blade page 160											✓	✓	✓

A broad range of blades available for all possible applications



Nail Buster

BI-METAL
stays sharper
for longer



Nail Buster Extreme

**3X
LIFE**

**TITANIUM
NITRIDE
COATING**
for faster cutting
& longer life

BI-METAL
stays sharper
for longer

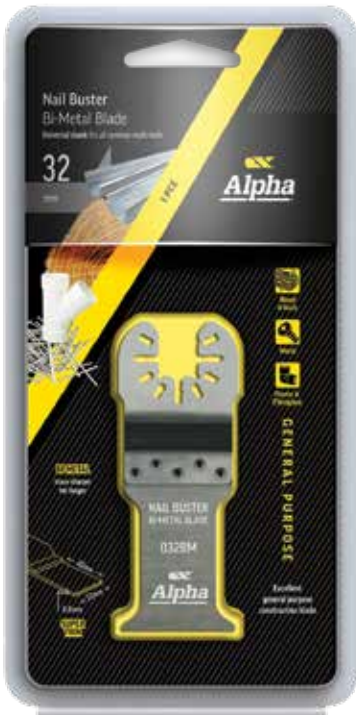

CARDED Supplied on hangable card



Nail Buster Bi-Metal Blade

BI-METAL
stays sharper
for longer



General purpose construction blade
Ideal for: Wood with nails, timber moulding, non-ferrous metal, plaster, plasterboard, fibreglass and plastic

- Bi-Metal for heavy duty quality and longer lasting teeth
- Super thin 0.8mm precision blade provides flexibility when working at odd angles while maintaining core strength

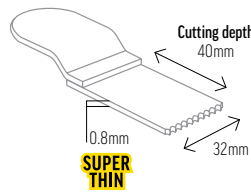

32mm 1 PIECE Code: 032BM1

32mm 3 PACK Code: 032BM3



CARDED Supplied on hangable card



Nail Buster Extreme Bi-Metal Blade

**3X
LIFE**

**TITANIUM
NITRIDE
COATING**
for faster cutting
& longer life

BI-METAL
stays sharper
for longer



General purpose construction blade
Ideal for: Wood with nails, timber moulding, non-ferrous metal, plaster, plasterboard, fibreglass and plastic

- Bi-Metal for heavy duty quality and longer lasting teeth
- Super thin 0.8mm precision blade provides flexibility when working at odd angles while maintaining core strength
- TiN coating reduces heat and increases lubricity for faster cutting and extended life
- Longer (56mm) reach for greater depth of cut

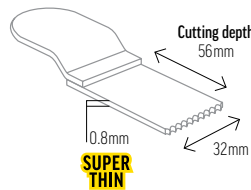

32mm 1 PIECE Code: 032BMT1

32mm 3 PACK Code: 032BMT3

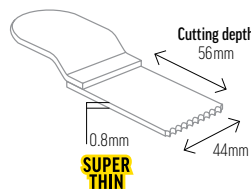

44mm 1 PIECE Code: 044BMT1

44mm 3 PACK Code: 044BMT3

Multi-material Blades



CARDED Supplied on hangable card



Surecut "Präzision" Bi-Metal Blade

**3X
LIFE**

**CURVED
CUTTING
EDGE**
for maximum
precision

BI-METAL
stays sharper
for longer



Wood & Nails



Metal



Plastic & Fibreglass

General purpose blade

Ideal for: Wood with nails, timber moulding, non-ferrous metal, plaster, plasterboard, fibreglass and plastic

- Curved cutting edge for maximum precision
- Bi-Metal for heavy duty quality and longer lasting teeth
- Super thin 0.8mm precision blade provides flexibility when working at odd angles while maintaining core strength

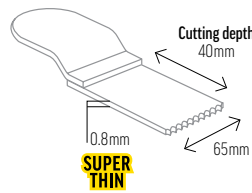

65mm 1 PIECE Code: 065BMC1

65mm 3 PACK Code: 065BMC3



CARDED Supplied on hangable card

HSS Segment Bi-Metal Blade

**3X
LIFE**

BI-METAL
stays sharper
for longer

**SUPER
THIN**
precise cutting



Wood & Nails



Metal



Plastic & Fibreglass

Ideal for: Wood with nails, timber moulding, non-ferrous metal, fibreglass and plastic

- Bi-Metal for heavy duty quality and longer lasting teeth
- Super thin 0.8mm precision blade provides flexibility when working at odd angles while maintaining core strength

PLUNGE CUT



90mm 1 PIECE Code: 090SB1



CARDED Supplied on hangable card



Metal Buster ^{6x LIFE} Tungsten Carbide Blade



Ideal for: Wood with nails, non-ferrous metal, screws, bolts, threaded rod and nails

- **Tungsten Carbide Tooth (TCT)** blade for clean cutting and 6 times life
- **1.25mm precision blade** provides flexibility when working at odd angles while maintaining core strength

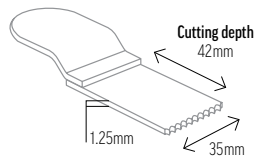

35mm 1 PIECE Code: 035TCT1



Timber Blades



CARDED Supplied on hangable card



Wood



Plastic

Ideal for: Wood, timber moulding, plaster, plasterboard and plastic

Fine Tooth Timber Blade

FINE TOOTH

ideal for intricate cutting

- Fine tooth design for precise and intricate cutting
- Super thin 0.8mm precision blade provides flexibility when working at odd angles while maintaining core strength
- Perfect for window and door hardware cutouts

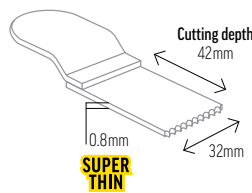

32mm 1 PIECE Code: 032FT1



CARDED Supplied on hangable card



Wood



Plastic

Ideal for: Wood, timber moulding, plaster, plasterboard and plastic

Coarse Tooth Timber Blade

COARSE TOOTH

ideal FAST timber cutting

- Coarse tooth design for fast timber cutting
- Super thin 0.8mm precision blade provides flexibility when working at odd angles while maintaining core strength

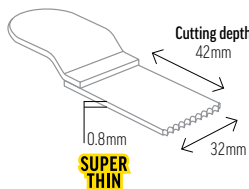

32mm 1 PIECE Code: 032CT1

32mm 3 PACK Code: 032CT3

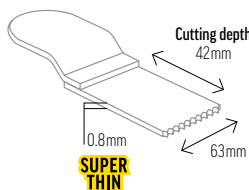

63mm 1 PIECE Code: 063CT1

63mm 3 PACK Code: 063CT3

Coarse Tooth Hardwood Blade

**3X
LIFE**

**HEAT
TREATED**

**HEAVY
DUTY**

Heat treated, hard pointed teeth for extended life



Hardwood



Plastic

Ideal for: Hardwood, timber moulding, plaster, plasterboard and plastic

- Heat treated, hard pointed teeth extends working life when cutting hardwood
- Super thin 0.8mm precision blade provides flexibility when working at odd angles while maintaining core strength



CARDED Supplied on hangable card

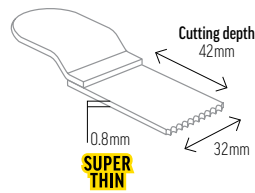

35mm 1 PIECE Code: 035HCT1

35mm 3 PACK Code: 035HCT3

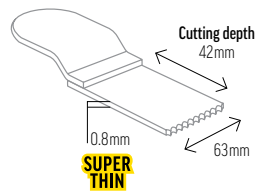

63mm 1 PIECE Code: 063HCT1

63mm 3 PACK Code: 063HCT3

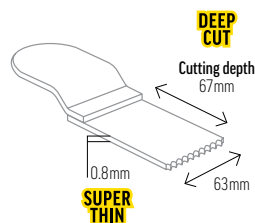

Deep cut: Cuts up to 67mm

32mm 1 PIECE Code: 032CTL1

Deep cut available





CARDED Supplied on hangable card



Japanese Tooth Timber Blade

3x LIFE

DUAL ACTION
ideal for
FAST
timber cutting



Wood



Plastic

General purpose blade

Ideal for: Wood, timber moulding, plaster, plasterboard, plastic and timber overlay flooring

- Japanese tooth design for precise and plunge cutting
- Dual action coarse tooth design for fast timber cutting
- Super thin 0.8mm precision blade provides flexibility when working at odd angles while maintaining core strength

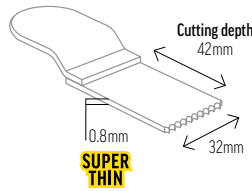

32mm 1 PIECE Code: 032JT1

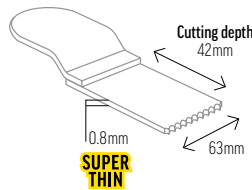

63mm 1 PIECE Code: 063JT1



CARDED Supplied on hangable card

Tungsten Carbide Segment Blade

TUNGSTEN CARBIDE GRIT

aggressively remove grout without damaging tiles



Grout Removal

Ideal for: Removing grout between tiles

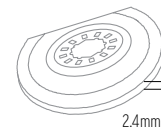

1 PIECE Code: CSB1



CARDED Supplied on hangable card

Sanding Pad Hook & Loop

HOOK & LOOP BACKING
for quick changeover

Ideal for precision sanding into tight areas and corners



1 PIECE Code: SP082QR



CARDED Supplied on hangable card

Sanding Sheets

HOOK & LOOP BACKING
for quick changeover

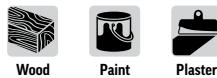

Ideal for: Wood, paint and plaster

Size: 82mm triangular

- 60 grit 5 PACK Code: SS06005
- 80 grit 5 PACK Code: SS08005
- 120 grit 5 PACK Code: SS12005
- 180 grit 5 PACK Code: SS18005
- 240 grit 5 PACK Code: SS24005

Multi-tool Blade Sets

Alpha's multi-tool sets contain the perfect blade selection to cut a wide range of materials

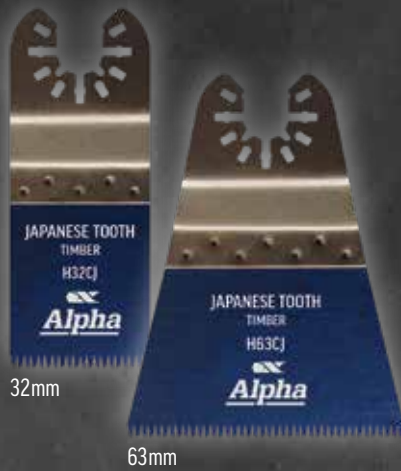

Japanese Tooth

Ideal for: Wood, plastic and timber overlay flooring

- Japanese tooth design for precise and plunge cutting
- Dual action coarse tooth design for fast timber cutting
- Super thin 0.8mm precision blade provides flexibility when working at odd angles while maintaining core strength
- Plunge cut

Cutting depth: 42mm



Bi-Metal Blade 32mm

Ideal for: Wood with nails, screws, plastic, fibreglass and non-ferrous metal

- Bi-Metal for heavy duty quality and longer lasting teeth
- Deep cutting depth allows for thick timber cuts
- Super thin 0.8mm precision blade provides flexibility when working at odd angles while maintaining core strength

Cutting depth: 51mm

Fine Tooth Blade 32mm

Ideal for: General purpose, wood and plastic cutting

- Fine tooth design for precise and intricate cutting
- Perfect for window and door hardware cut-outs
- Super thin 0.8mm precision blade provides flexibility when working at odd angles while maintaining core strength

Cutting depth: 42mm

4 PCE Multi-tool Blade Set

- 1 x Japanese Tooth Blade 32mm
- 1 x Japanese Tooth Blade 63mm
- 1 x Bi-Metal Blade 32mm
- 1 x Fine Tooth Blade 32mm

10 sets per counter display

Code: H4MAK

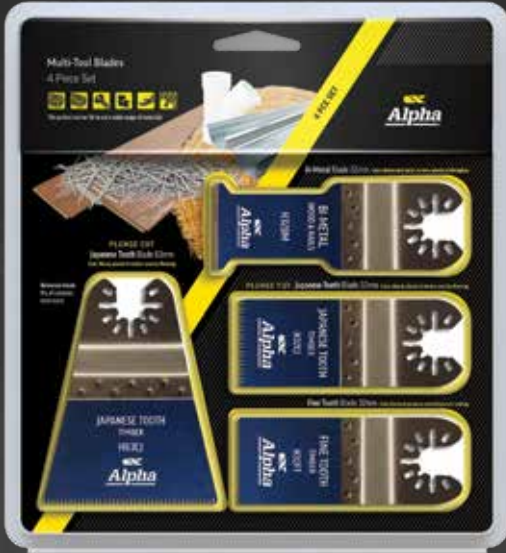

8 PCE Multi-tool Blade Set

- 2 x Japanese Tooth Blade 32mm
- 2 x Japanese Tooth Blade 63mm
- 2 x Bi-Metal Blade 32mm
- 2 x Fine Tooth Blade 32mm

6 sets per counter display

Code: H8PRO



Durable plastic box

Merchandiser



Size (mm):
600 W x
420 H x 270 D

Core Range Merchandiser & Counter Display

15 SKUS
39 items

+

**1 COUNTER
DISPLAY**
10 sets

MERCHANDISER ITEM	SIZE	Items per pack	CODE	QTY
Nail Buster Bi-Metal Blade	32mm	1 PCE	032BM1	3
Nail Buster Extreme Bi-Metal Blade	32mm	1 PCE	032BMT1	2
	44mm	1 PCE	044BMT1	2
Surecut "Präzision" Bi-Metal Blade	65mm	1 PCE	065BMC1	2
HSS Segment Bi-Metal Blade	90mm	1 PCE	090SB1	2
Metal Buster Tungsten Carbide Blade	35mm	1 PCE	035TCT1	2
Fine Tooth Timber Blade	32mm	1 PCE	032FT1	3
Coarse Tooth Timber Blade	32mm	1 PCE	032CT1	3
	63mm	1 PCE	063CT1	3
	35mm	1 PCE	035HCT1	3
Coarse Tooth Hardwood Blade	63mm	1 PCE	063HCT1	3
	32mm Deep Cut	1 PCE	032CTL1	3

MERCHANDISER ITEM	SIZE	Items per pack	CODE	QTY
Japanese Tooth Timber Blade	32mm	1 PCE	032JT1	3
	63mm	1 PCE	063JT1	3
Tungsten Carbide Segment Blade	n/a	1 PCE	CSB1	2

COUNTER DISPLAY ITEM	Items per counter display	CODE	QTY
4 PCE Multi-tool Blade Set	10 SETS	H4MAK	1

Code: MULTI-CORE

Core range includes the
best seller counter display:
10 x 4 piece starter kits



Size (mm): 600 W
x 420 H x 270 D
(each)



Full Range Merchandiser Duo & Counter Displays

29 SKUS
73 items

**+ 2 COUNTER
DISPLAYS**
16 sets

MERCHANDISER ITEM	SIZE / GRIT	Items per pack	CODE	QTY
Nail Buster Bi-Metal Blade	32mm	1 PCE	032BM1	3
	32mm	3 PACK	032BM3	2
	32mm	1 PCE	032BMT1	2
Nail Buster Extreme Bi-Metal Blade	32mm	3 PACK	032BMT3	2
	44mm	1 PCE	044BMT1	2
	44mm	3 PACK	044BMT3	2
Surecut "Präzision" Bi-Metal Blade	65mm	1 PCE	065BMC1	2
	65mm	3 PACK	065BMC3	2
HSS Segment Bi-Metal Blade	90mm	1 PCE	090SB1	2
Metal Buster Tungsten Carbide Blade	35mm	1 PCE	035TCT1	2
Fine Tooth Timber Blade	32mm	1 PCE	032FT1	3
	32mm	1 PCE	032CT1	3
Coarse Tooth Timber Blade	32mm	3 PACK	032CT3	2
	63mm	1 PCE	063CT1	3
	63mm	3 PACK	063CT3	2
	35mm	1 PCE	035HCT1	3
	35mm	3 PACK	035HCT3	2
Coarse Tooth Hardwood Blade	63mm	1 PCE	063HCT1	3
	63mm	3 PACK	063HCT3	2
	32mm Deep Cut	1 PCE	032CTL1	3
Japanese Tooth Timber Blade	32mm	1 PCE	032JT1	3
	63mm	1 PCE	063JT1	3
Tungsten Carbide Segment Blade	n/a	1 PCE	CSB1	2
Sanding Pad	82mm TRI	1 PCE	SP082QR	3

MERCHANDISER ITEM	SIZE / GRIT	Items per pack	CODE	QTY
	60 grit	5 PACK	SS06005	3
	80 grit	5 PACK	SS08005	3
Sanding Sheets	120 grit	5 PACK	SS12005	3
	180 grit	5 PACK	SS18005	3
	240 grit	5 PACK	SS24005	3

COUNTER DISPLAY ITEM	Items per counter display	CODE	QTY
4 PCE Multi-tool Blade Set	10 SETS	H4MAK	1
8 PCE Multi-tool Blade Set	6 SETS	H8PRO	1

Code: MULTI-DUO



Full range includes two best seller counter displays:
10 x 4 piece starter kits
6 x 8 piece starter kits



Carbide Burrs

Cylindrical Smooth End	170
Cylindrical End Cut	171
Cylindrical Ball Nose	172
Ball	173
Oval	174
Tree Radius Nose	175
Tree Pointed Nose	176
Flame	177
90° Cone	177
Included Angle	178
Pointed Cone	179
Inverted Cone	179
Counter Merchandisers	180
Sets	181

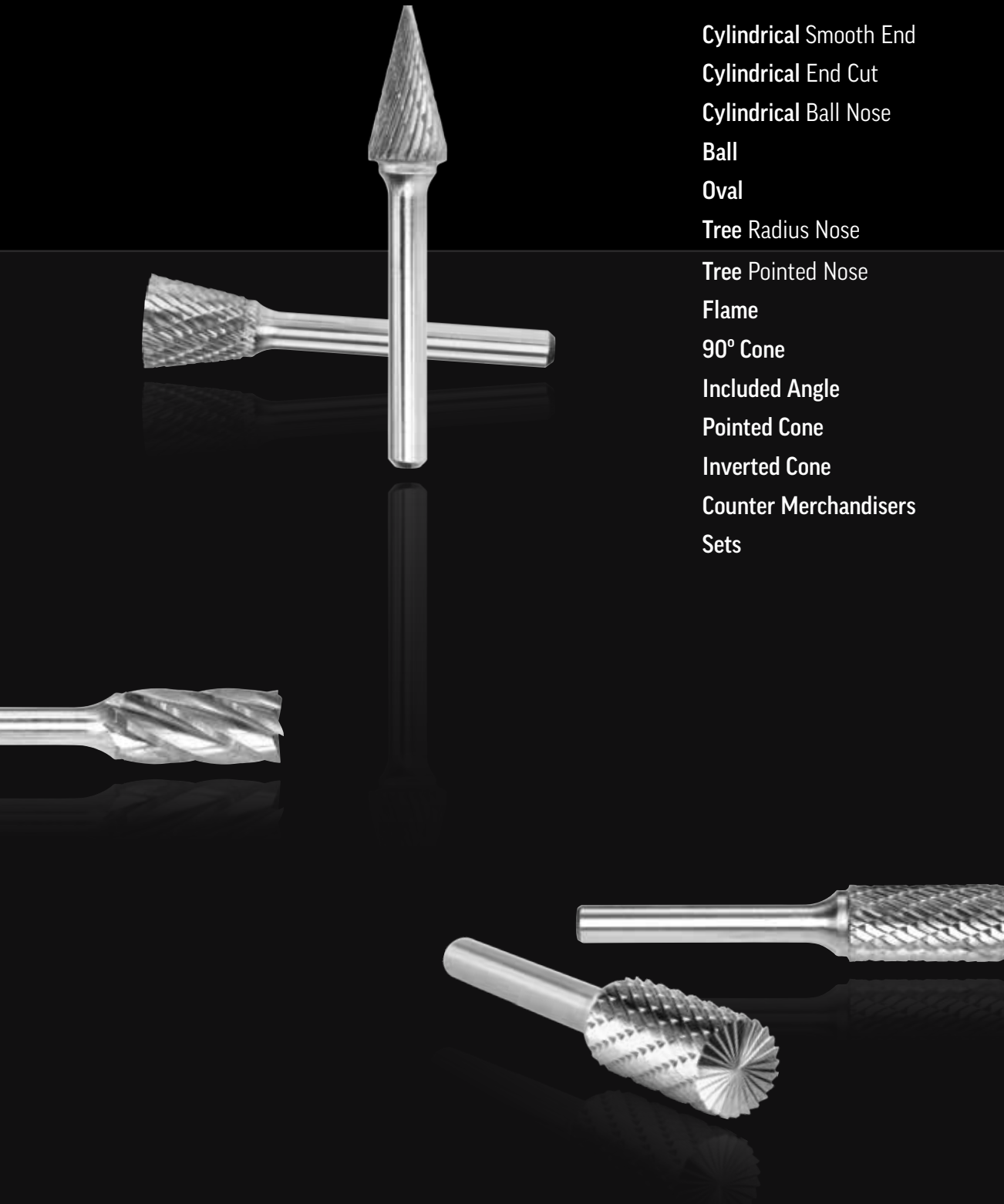

CARBIDE BURRS

Alpha carbide burrs are offered in an array of shapes, fluting patterns and lengths, suitable for all types of deburring applications. Precision flute grinding ensures chatterless operation and long tool life.

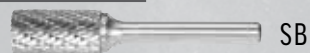
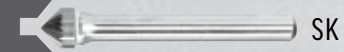
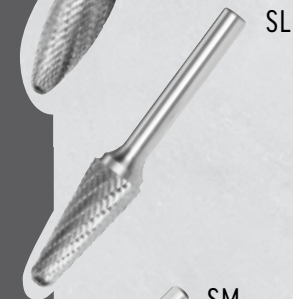



Long Series



BULK - 1 PCE
Supplied in hangable plastic pack

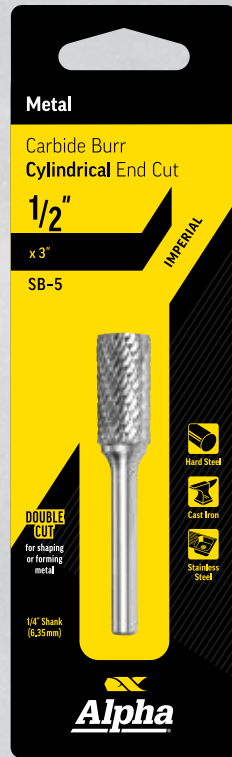

CARDED* - 1 PCE
Supplied in hangable card

DOUBLE CUT



Hard Steel



Cast Iron



Stainless Steel

Double Cut Carbide Burrs for shaping or forming metal

Ideal for: Hardened and unhardened steel, stainless steel, titanium, brass, copper, cast iron and bronze

- Cross-cut gearing for rapid stock removal in hard materials, providing better control
- Made from solid carbide

Suits: Air and electric die grinders

6" Long Series available in a range of styles

*New carded range pending



BULK - 1 PCE
Supplied in hangable plastic pack

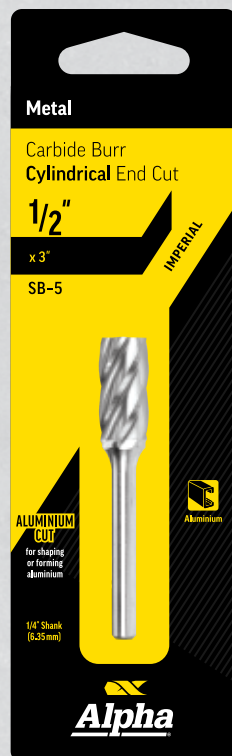

CARDED* - 1 PCE
Supplied in hangable card

ALUMINIUM CUT



Aluminium

Aluminium Cut Carbide Burrs for shaping or forming aluminium

Ideal for: Aluminium and other soft materials such as brass, copper and plastics

- Chisel tooth pattern minimises tool chatter, and reduces the chip to a granular shape, in most materials
- Rapid removal of soft materials, that would normally load other cuts
- Made from solid carbide

Suits: Air and electric die grinders

*New carded range pending

Cylindrical Smooth End

DOUBLE CUT – SA TYPE Cylindrical Smooth End



Smooth End



**DOUBLE
CUT**

IMPERIAL

1/8" SHANK

Head ø inches	OAL inches	FL inches	Style	BULK 1 per pack	
1/16	1 1/2	1/4	SA-41	SA-41DC	
3/32	1 1/2	7/16	SA-42	SA-42DC	
1/8	1 1/2	9/16	SA-43	SA-43DC	
5/32	1 1/2	1/2	SA-52	SA-52DC	
3/16	1 1/2	1/2	SA-53	SA-53DC	
1/4	2	1/2	SA-51	SA-51DC	

1/4" SHANK

Head ø inches	OAL inches	FL inches	Style	BULK 1 per pack	CARDED* 1 per card
1/8	2	1/2	SA-11	SA-11DC	
1/4	2	5/8	SA-1	SA-1DC	CSA-1DC
5/16	2 3/4	3/4	SA-2	SA-2DC	
3/8	2 3/4	3/4	SA-3	SA-3DC	CSA-3DC
7/16	3	1	SA-4	SA-4DC	
1/2	3	1	SA-5	SA-5DC	CSA-5DC
5/8	3	1	SA-6	SA-6DC	
3/4	3	1	SA-7	SA-7DC	
1	3	1	SA-9	SA-9DC	

*New carded range pending

1/4" SHANK – LONG SERIES

Head ø inches	OAL inches	FL inches	Style	BULK 1 per pack	
1/4	6 1/2	5/8	SA-1	SA-1L6	
3/8	6 3/4	3/4	SA-3	SA-3L6	
1/2	7	1	SA-5	SA-5L6	

METRIC

3mm SHANK

Head ø mm	OAL mm	FL mm	Style	BULK 1 per pack
1.5	38	6.0	SA-41	SA-41MDC
3.0	38	14.0	SA-43	SA-43MDC
6.3	50	12.7	SA-51	SA-51MDC

6mm SHANK

Head ø mm	OAL mm	FL mm	Style	BULK 1 per pack
4.7	50	16	SA-14	SA-14MDC
6.0	50	16	SA-1	SA-1MDC
8.0	63	19	SA-2	SA-2MDC
9.5	63	19	SA-3	SA-3MDC
12.7	68	25	SA-5	SA-5MDC
16.0	68	25	SA-6	SA-6MDC
25.4	68	25	SA-9	SA-9MDC

ALUMINIUM CUT – SA TYPE Cylindrical Smooth End



Smooth End



**ALUMINIUM
CUT**

IMPERIAL

1/4" SHANK

Head ø inches	OAL inches	FL inches	Style	BULK 1 per pack	CARDED* 1 per card
1/4	2	1/4	SA-1	SA-1AL	
3/8	2 3/4	3/4	SA-3	SA-3AL	CSA-3AL
1/2	3	1	SA-5	SA-5AL	CSA-5AL
5/8	3	1	SA-6	SA-6AL	
3/4	3	1	SA-7	SA-7AL	

*New carded range pending

METRIC

6mm SHANK

Head ø mm	OAL mm	FL mm	Style	BULK 1 per pack
6.0	50	19	SA-1	SA-1MAL
9.5	63	19	SA-3	SA-3MAL
12.7	68	25	SA-5	SA-5MAL

DOUBLE CUT – SB TYPE Cylindrical End Cut



End Cut



DOUBLE CUT

IMPERIAL

1/8" SHANK

Head ø inches	OAL inches	FL inches	Style	BULK 1 per pack	
1/4	2	1/2	SB-51	SB-51DC	

1/4" SHANK

Head ø inches	OAL inches	FL inches	Style	BULK 1 per pack	CARDED* 1 per card
1/8	2	1/2	SB-11	SB-11DC	
3/16	2	5/8	SB-14	SB-14DC	
1/4	2	5/8	SB-1	SB-1DC	CSB-1DC
5/16	2 3/4	3/4	SB-2	SB-2DC	
3/8	2 3/4	3/4	SB-3	SB-3DC	CSB-3DC
7/16	3	1	SB-4	SB-4DC	
1/2	3	1	SB-5	SB-5DC	CSB-5DC
5/8	3	1	SB-6	SB-6DC	
3/4	3	1	SB-7	SB-7DC	

*New carded range pending

METRIC

6mm SHANK

Head ø mm	OAL mm	FL mm	Style	BULK 1 per pack
4.7	50	16	SB-14	SB-14MDC
6.0	50	16	SB-1	SB-1MDC
8.0	63	20	SB-2	SB-2MDC
9.5	63	19	SB-3	SB-3MDC
11.0	68	25	SB-4	SB-4MDC
12.7	68	25	SB-5	SB-5MDC
16.0	68	25	SB-6	SB-6MDC
19.0	68	25	SB-7	SB-7MDC

ALUMINIUM CUT – SB TYPE Cylindrical End Cut



End Cut



ALUMINIUM CUT

IMPERIAL

1/4" SHANK

Head ø inches	OAL inches	FL inches	Style	BULK 1 per pack	CARDED* 1 per card
3/8	2	3/4	SB-3	SB-3AL	
5/8	3	1	SB-5	SB-5AL	CSB-5AL

*New carded range pending

Cylindrical Ball Nose

DOUBLE CUT – SC TYPE

Cylindrical Ball Nose



DOUBLE CUT

IMPERIAL

1/8" SHANK

Head ø inches	OAL inches	FL inches	Style	BULK 1 per pack
3/32	1 1/2	7/16	SC-41	SC-41DC
1/8	1 1/2	9/16	SC-42	SC-42DC
5/32	1 1/2	1/2	SC-52	SC-52DC
3/16	1 1/2	1/2	SC-53	SC-53DC
1/4	2	3/16	SC-51	SC-51DC

1/4" SHANK

Head ø inches	OAL inches	FL inches	Style	BULK 1 per pack	CARDED* 1 per card
1/8	2	1/2	SC-11	SC-11DC	
3/16	2	5/8	SC-14	SC-14DC	
1/4	2	3/4	SC-1	SC-1DC	CSC-1DC
5/16	2 3/4	3/4	SC-2	SC-2DC	
3/8	2 3/4	3/4	SC-3	SC-3DC	CSC-3DC
7/16	3	1	SC-4	SC-4DC	
1/2	3	1	SC-5	SC-5DC	CSC-5DC
5/8	3	1	SC-6	SC-6DC	
3/4	3	1	SC-7	SC-7DC	

*New carded range pending

1/4" SHANK – LONG SERIES

Head ø inches	OAL inches	FL inches	Style	BULK 1 per pack
1/4	6 1/2	1/2	SC-1	SC-1L6
3/8	6 3/4	3/4	SC-3	SC-3L6
1/2	7	1	SC-5	SC-5L6

METRIC

3mm SHANK

Head ø mm	OAL mm	FL mm	Style	BULK 1 per pack
2.5	38	11	SC-41	SC-41MDC
3.0	38	14	SC-42	SC-42MDC

6mm SHANK

Head ø mm	OAL mm	FL mm	Style	BULK 1 per pack
4.7	50	16	SC-14	SC-14MDC
6.0	50	16	SC-1	SC-1MDC
8.0	63	20	SC-2	SC-2MDC
9.5	63	19	SC-3	SC-3MDC
11.0	68	25	SC-4	SC-4MDC
12.7	68	25	SC-5	SC-5MDC
16.0	68	25	SC-6	SC-6MDC
19.0	68	25	SC-7	SC-7MDC

6mm SHANK – LONG SERIES

Head ø mm	OAL mm	FL mm	Style	BULK 1 per pack
6.0	163	12.7	SC-1	SC-1ML6
9.5	171	19	SC-3	SC-3ML6
12.7	177	25	SC-5	SC-5ML6

ALUMINIUM CUT – SC TYPE

Cylindrical Ball Nose



ALUMINIUM CUT

IMPERIAL

1/4" SHANK

Head ø inches	OAL inches	FL inches	Style	BULK 1 per pack	CARDED* 1 per card
1/4	2	3/4	SC-1	SC-1AL	
3/8	2 3/4	3/4	SC-3	SC-3AL	CSC-3AL
1/2	3	1	SC-5	SC-5AL	CSC-5AL
5/8	3	1	SC-6	SC-6AL	
3/4	3	1	SC-7	SC-7AL	

*New carded range pending

METRIC

6mm SHANK

Head ø mm	OAL mm	FL mm	Style	BULK 1 per pack
6.0	50	19	SC-1	SC-1MAL
9.5	63	19	SC-3	SC-3MAL
12.7	68	25	SC-5	SC-5MAL

DOUBLE CUT – SD TYPE

Ball



DOUBLE CUT

IMPERIAL

1/8" SHANK

Head ø inches	OAL inches	FL inches	Style	BULK 1 per pack
3/32	1 1/2	1/16	SD-41	SD-41DC
1/8	1 1/2	3/32	SD-42	SD-42DC
3/16	1 1/2	1/8	SD-53	SD-53DC
1/4	1 11/16	7/32	SD-51	SD-51DC

1/4" SHANK

Head ø inches	OAL inches	FL inches	Style	BULK 1 per pack	CARDED* 1 per card
1/8	2	3/32	SD-11	SD-11DC	
3/16	2	5/32	SD-14	SD-14DC	
1/4	2	7/32	SD-1	SD-1DC	CSD-1DC
5/16	2 1/4	1/4	SD-2	SD-2DC	
3/8	2 5/16	5/16	SD-3	SD-3DC	CSD-3DC
7/16	2 3/8	3/8	SD-4	SD-4DC	
1/2	2 7/16	7/16	SD-5	SD-5DC	CSD-5DC
5/8	2 9/16	9/16	SD-6	SD-6DC	
3/4	2 11/16	11/16	SD-7	SD-7DC	
1	2 15/16	15/16	SD-9	SD-9DC	

*New carded range pending

1/4" SHANK – LONG SERIES

Head ø inches	OAL inches	FL inches	Style	BULK 1 per pack
1/4	6 1/8	7/32	SD-1	SD-1L6
3/8	6 1/4	5/16	SD-3	SD-3L6
1/2	6 3/8	7/16	SD-5	SD-5L6

METRIC

3mm SHANK

Head ø mm	OAL mm	FL mm	Style	BULK 1 per pack
3.0	38	2	SD-42	SD-42MDC

6mm SHANK

Head ø mm	OAL mm	FL mm	Style	BULK 1 per pack
3.0	50	2	SD-11	SD-11MDC
6.0	50	5	SD-1	SD-1MDC
8.0	50	7	SD-2	SD-2MDC
9.5	52	8	SD-3	SD-3MDC
12.7	54	11	SD-5	SD-5MDC
16.0	58	14	SD-6	SD-6MDC

6mm SHANK – LONG SERIES

Head ø mm	OAL mm	FL mm	Style	BULK 1 per pack
9.5	161	8	SD-3	SC-3ML6
12.7	164	11	SD-5	SC-5ML6

ALUMINIUM CUT – SD TYPE

Ball



ALUMINIUM CUT

IMPERIAL

1/4" SHANK

Head ø inches	OAL inches	FL inches	Style	BULK 1 per pack
1/4	2	7/32	SD-1	SD-1AL
3/8	2 5/16	5/16	SD-3	SD-3AL
1/2	2 7/16	7/16	SD-5	SD-5AL
5/8	2 9/16	9/16	SD-6	SD-6AL

METRIC

6mm SHANK

Head ø mm	OAL mm	FL mm	Style	BULK 1 per pack
9.5	52	8	SD-2	SD-3MAL
12.7	54	11	SD-5	SD-5MAL

Oval

DOUBLE CUT – SE TYPE

Oval



DOUBLE CUT

IMPERIAL

1/8" SHANK

Head ø inches	OAL inches	FL inches	Style	BULK 1 per pack
1/8	1 1/2	7/32	SE-41	SE-41DC
3/16	1 1/2	9/32	SE-53	SE-53DC
1/4	1 7/8	3/8	SE-51	SE-51DC

1/4" SHANK

Head ø inches	OAL inches	FL inches	Style	BULK 1 per pack
1/4	2	3/8	SE-1	SE-1DC
3/8	2 5/8	5/8	SE-3	SE-3DC
1/2	2 7/8	7/8	SE-5	SE-5DC
5/8	3	1	SE-6	SE-6DC
3/4	3	1	SE-7	SE-7DC

1/4" SHANK – LONG SERIES

Head ø inches	OAL inches	FL inches	Style	BULK 1 per pack
1/4	4 3/8	3/8	SE-1	SE-1L4
3/8	6 5/8	5/8	SE-3	SE-3L6**
1/2	6 7/8	7/8	SE-5	SE-5L6***

**Also available in single cut (code: SE-3L6SC)

***Also available in single cut (code: SE-5L6SC)

METRIC

3mm SHANK

Head ø mm	OAL mm	FL mm	Style	BULK 1 per pack
6.3	47	9.5	SE-51	SE-51MDC

6mm SHANK

Head ø mm	OAL mm	FL mm	Style	BULK 1 per pack
6.0	50	10	SE-1	SE-1MDC
9.5	60	16	SE-3	SE-3MDC
12.7	66	22	SE-5	SE-5MDC

6mm SHANK – LONG SERIES

Head ø mm	OAL mm	FL mm	Style	BULK 1 per pack
6.3	111	10	SE-1	SE-1ML4
12.7	177	22	SE-5	SE-5ML6

ALUMINIUM CUT – SE TYPE

Oval



ALUMINIUM CUT

IMPERIAL

1/4" SHANK

Head ø inches	OAL inches	FL inches	Style	BULK 1 per pack
3/8	2 5/8	5/8	SE-3	SE-3AL
1/2	2 7/8	7/8	SE-5	SE-5AL
5/8	3	1	SE-6	SE-6AL

METRIC

6mm SHANK

Head ø mm	OAL mm	FL mm	Style	BULK 1 per pack
9.5	60	16	SE-3	SE-3MAL
12.7	66	22	SE-5	SE-5MAL

DOUBLE CUT – SF TYPE Tree Radius Nose



**DOUBLE
CUT**

IMPERIAL

1/4" SHANK

Head ø inches	OAL inches	FL inches	Style	BULK 1 per pack
1/8	1 1/2	1/4	SF-41	SF-41DC
1/8	1 1/2	1/2	SF-42	SF-42DC
3/16	1 1/2	1/2	SF-53	SF-53DC
1/4	2	1/2	SF-51	SF-51DC

1/4" SHANK

Head ø inches	OAL inches	FL inches	Style	BULK 1 per pack	CARDED* 1 per card
1/4	2	3/4	SF-1	SF-1DC	CSF-1DC
3/8	2 3/4	3/4	SF-3	SF-3DC	CSF-3DC
7/16	3	1	SF-4	SF-4DC	
1/2	3	1	SF-5	SF-5DC	CSF-5DC
1/2	2 3/4	3/4	SF-13	SF-13DC	
5/8	3	1	SF-6	SF-6DC	
3/4	3 1/4	1 1/4	SF-14	SF-14DC	
3/4	3	1	SF-7	SF-7DC	
3/4	3 1/2	1 1/2	SF-15	SF-15DC	

*New carded range pending

1/4" SHANK – LONG SERIES

Head ø inches	OAL inches	FL inches	Style	BULK 1 per pack
1/4	6 1/2	1/2	SF-1	SF-1L6
3/8	6 3/4	3/4	SF-3	SF-3L6
1/2	7	1	SF-5	SF-5L6

METRIC

3mm SHANK

Head ø mm	OAL mm	FL mm	Style	BULK 1 per pack
6.3	50	13	SF-51	SF-51MDC

6mm SHANK

Head ø mm	OAL mm	FL mm	Style	BULK 1 per pack
6.0	50	19	SF-1	SF-1MDC
9.5	63	19	SF-3	SF-3MDC
12.7	68	25	SF-5	SF-5MDC
16.0	68	25	SF-6	SF-6MDC
19.0	68	25	SF-7	SF-7MDC

6mm SHANK – LONG SERIES

Head ø mm	OAL mm	FL mm	Style	BULK 1 per pack
6.0	163	13	SF-1	SF-1ML6
9.5	171	19	SF-3	SF-3ML6
12.7	177	25	SF-5	SF-5ML6

ALUMINIUM CUT – SF TYPE Tree Radius Nose



**ALUMINIUM
CUT**

IMPERIAL

1/4" SHANK

Head ø inches	OAL inches	FL inches	Style	BULK 1 per pack
1/4	2	3/4	SF-1	SF-1AL
3/8	2 3/4	3/4	SF-3	SF-3AL
1/2	3	1	SF-5	SF-5AL
5/8	3	1	SF-6	SF-6AL

METRIC

6mm SHANK

Head ø mm	OAL mm	FL mm	Style	BULK 1 per pack
6.0	50	19	SF-1	SF-1MAL
9.5	63	19	SF-3	SF-3MAL

Tree Pointed Nose

DOUBLE CUT – SG TYPE Tree Pointed Nose



**DOUBLE
CUT**

IMPERIAL

1/8" SHANK

Head ø inches	OAL inches	FL inches	Style	BULK 1 per pack
1/8	1 1/2	1/4	SG-41	SG-41DC
1/8	1 1/2	5/16	SG-42	SG-42DC
1/8	1 1/2	3/8	SG-43	SG-43DC
1/8	1 1/2	1/2	SG-44	SG-44DC
3/16	1 1/2	1/2	SG-53	SG-53DC
1/4	2	1/2	SG-51	SG-51DC

1/4" SHANK

Head ø inches	OAL inches	FL inches	Style	BULK 1 per pack	CARDED* 1 per card
1/4	2	3/4	SG-1	SG-1DC	CSG-1DC
5/16	2 3/4	3/4	SG-2	SG-2DC	
3/8	2 3/4	3/4	SG-3	SG-3DC	CSG-3DC
1/2	2 3/4	3/4	SG-13	SG-13DC	CSG-13DC
1/2	3	1	SG-5	SG-5DC	
5/8	3	1	SG-6	SG-6DC	
3/4	3	1	SG-7	SG-7DC	

*New carded range pending

METRIC

3mm SHANK

Head ø mm	OAL mm	FL mm	Style	BULK 1 per pack
6.3	50	13	SG-51	SG-51MDC

6mm SHANK

Head ø mm	OAL mm	FL mm	Style	BULK 1 per pack
6.0	50	19	SG-1	SG-1MDC
8.0	63	19	SG-2	SG-2MDC
9.5	63	19	SG-3	SG-3MDC
12.7	68	25	SG-5	SG-5MDC

DOUBLE CUT – SH TYPE

Flame



DOUBLE CUT

IMPERIAL

1/8" SHANK

Head ø inches	OAL inches	FL inches	Style	BULK 1 per pack
1/8	1 1/2	1/4	SH-41	SH-41DC
3/16	1 1/2	3/8	SH-53	SH-53DC

1/4" SHANK

Head ø inches	OAL inches	FL inches	Style	BULK 1 per pack	CARDED* 1 per card
5/16	2 3/4	3/4	SH-2	SH-2DC	CSH-2DC
1/2	3 1/4	1 1/4	SH-5	SH-5DC	CSH-5DC
5/8	3 7/16	1 7/16	SH-6	SH-6DC	
3/4	3 5/8	1 5/8	SH-7	SH-7DC	

*New carded range pending

METRIC

6mm SHANK

Head ø mm	OAL mm	FL mm	Style	BULK 1 per pack
8.0	63	19	SH-2	SH-2MDC
12.7	75	31	SH-5	SH-5MDC
16.0	79	36	SH-6	SH-6MDC
19.0	84	41	SH-7	SH-7MDC

SINGLE CUT – SK TYPE

90° Cone



SINGLE CUT

IMPERIAL

1/4" SHANK

Head ø inches	OAL inches	FL inches	Style	Angle	BULK 1 per pack
1/4	2	1/8	SK-1	90°	SK-1SC
3/8	2 5/16	3/16	SK-3	90°	SK-3SC

Included Angle

DOUBLE CUT - SL TYPE Included Angle



**DOUBLE
CUT**

IMPERIAL

1/8" SHANK

Head ø inches	OAL inches	FL inches	Style	Angle	BULK 1 per pack
1/8	1 1/2	3/8	SL-41	10°	SL-41DC
1/8	1 1/2	1/2	SL-42	8°	SL-42DC
3/16	1 1/2	1/2	SL-53	14°	SL-53DC

1/4" SHANK

Head ø inches	OAL inches	FL inches	Style	Angle	BULK 1 per pack
1/4	2	5/8	SL-1	14°	SL-1DC
5/16	2 7/8	7/8	SL-2	14°	SL-2DC
3/8	3 1/16	1 1/16	SL-3	14°	SL-3DC
1/2	3 1/8	1 1/8	SL-4	14°	SL-4DC
5/8	3 5/16	1 5/16	SL-6	14°	SL-6DC
3/4	3 1/2	1 1/2	SL-7	14°	SL-7DC

1/4" SHANK - LONG SERIES

Head ø inches	OAL inches	FL inches	Style	Angle	BULK 1 per pack
1/4	6 5/8	5/8	SL-1	14°	SL-1L6
3/8	7	1 1/16	SL-3	14°	SL-3L6*
1/2	7 1/8	1 1/8	SL-4	14°	SL-4L6

*Also available in single cut (code: SC-3L6SC)

METRIC

6mm SHANK

Head ø mm	OAL mm	FL mm	Style	Angle	BULK 1 per pack
6.0	50	16	SL-1	14°	SL-1MDC
8.0	66	22	SL-2	14°	SL-2MDC
9.5	71	27	SL-3	14°	SL-3MDC
12.7	72	28	SL-4	14°	SL-4MDC

ALUMINIUM CUT - SL TYPE Included Angle



**ALUMINIUM
CUT**

IMPERIAL

1/4" SHANK

Head ø inches	OAL inches	FL inches	Style	Angle	BULK 1 per pack
3/8	3 1/16	1 1/16	SL-3	14°	SL-3AL
1/2	3 1/8	1 1/8	SL-4	14°	SL-4AL
5/8	3 5/16	1 5/16	SL-6	14°	SL-6AL

METRIC

6mm SHANK

Head ø mm	OAL mm	FL mm	Style	Angle	BULK 1 per pack
12.7	72	28	SL-4	14°	SL-4MAL

DOUBLE CUT – SM TYPE

Pointed Cone



DOUBLE CUT

IMPERIAL

1/8" SHANK

Head ø inches	OAL inches	FL inches	Style	Angle	BULK 1 per pack
1/8	1 1/2	3/8	SM-41	12°	SM-41DC
1/8	1 1/2	7/16	SM-42	14°	SM-42DC
1/8	1 1/2	5/8	SM-43	7°	SM-43DC
3/16	1 1/2	1/2	SM-53	16°	SM-53DC
1/4	2	1/2	SM-51	22°	SM-51DC

1/4" SHANK

Head ø inches	OAL inches	FL inches	Style	Angle	BULK 1 per pack
1/4	2	1/2	SM-1	22°	SM-1DC
1/4	2	3/4	SM-2	14°	SM-2DC
1/4	2	1	SM-3	10°	SM-3DC
3/8	2 5/8	5/8	SM-4	28°	SM-4DC
1/2	2 7/8	7/8	SM-5	28°	SM-5DC
5/8	3	1	SM-6	31°	SM-6DC

METRIC

3mm SHANK

Head ø mm	OAL mm	FL mm	Style	Angle	BULK 1 per pack
4.7	38	12.7	SM-53	16°	SM-53MDC

6mm SHANK

Head ø mm	OAL mm	FL mm	Style	Angle	BULK 1 per pack
6.0	50	12.7	SM-1	22°	SM-1MDC
6.0	50	18	SM-2	14°	SM-2MDC
6.0	50	25	SM-3	10°	SM-3MDC
9.5	60	16	SM-4	28°	SM-4MDC
12.7	66	22	SM-5	28°	SM-5MDC
16.0	68	25	SM-6	31°	SM-6MDC

DOUBLE CUT – SN TYPE

Inverted Cone



DOUBLE CUT

IMPERIAL

1/8" SHANK

Head ø inches	OAL inches	FL inches	Style	Angle	BULK 1 per pack
1/8	1 1/2	3/16	SN-42	10°	SN-42DC
3/16	1 1/2	1/4	SN-53	10°	SN-53DC
1/4	1 3/4	1/4	SN-51	10°	SN-51DC

1/4" SHANK

Head ø inches	OAL inches	FL inches	Style	Angle	BULK 1 per pack
1/4	2	5/16	SN-1	10°	SN-1DC
3/8	2 3/8	3/8	SN-2	13°	SN-2DC
1/2	2 1/2	1/2	SN-3	16°	SN-3DC
1/2	2 1/2	1/2	SN-4	28°	SN-4DC
5/8	2 5/8	5/8	SN-5	19°	SN-5DC
5/8	2 3/4	3/4	SN-6	18°	SN-6DC

METRIC

6mm SHANK

Head ø mm	OAL mm	FL mm	Style	Angle	BULK 1 per pack
6.0	50	8	SN-1	10°	SN-1MDC

Counter Merchandisers



Small Bulk Burr Merchandiser

21 BURRS

- Displays 21 double cut burr sizes (1/4" shank) in common styles
- Lockable cover
- Rear packaging storage unit

Size (mm):
180 W x 230 H x 200 D

Code: **SMLBURR/DIS**

DOUBLE CUT Burr	HEAD ø	CODE	QTY
Cylindrical Smooth End	5/16"	SA-2DC	1
	3/8"	SA-3DC	1
	1/2"	SA-5DC	1
Cylindrical End Cut	3/8"	SB-3DC	1
	1/2"	SB-5DC	1
Cylindrical Ball Nose	5/16"	SC-2DC	1
	3/8"	SC-3DC	1
	1/2"	SC-5DC	1
Ball	5/16"	SD-2DC	1
	3/8"	SD-3DC	1
	1/2"	SC-5DC	1
Oval	3/8"	SE-3DC	1
	1/2"	SF-5DC	1
Tree Radius Nose	3/8"	SF-3DC	1
	1/2"	SF-5DC	1
Tree Pointed Nose	3/8"	SG-3DC	1
	1/2"	SG-5DC	1
Flame	5/16"	SH-2DC	1
	1/2"	SH-5DC	1
Included Angle	5/16"	SL-2DC	1
	1/2"	SL-4DC	1
Pointed Cone	1/4"	SM-3DC	1
Inverted Cone	1/4"	SN-1DC	1

Large Bulk Burr Merchandiser

- Displays 39 double cut and 7 aluminium cut burr sizes (1/4" shank) in common styles
- Lockable cover
- Rear packaging storage unit



46 BURRS

D. CUT Burr	HEAD ø	CODE	QTY
Cylindrical Smooth End	1/4"	SA-1DC	1
	5/16"	SA-2DC	1
	3/8"	SA-3DC	1
	1/2"	SA-5DC	1
Cylindrical End Cut	5/8	SA-6DC	1
	1/4"	SB-1DC	1
	5/16"	SB-2DC	1
	3/8"	SB-3DC	1
	1/2"	SB-5DC	1
	5/8	SB-6DC	1
Cylindrical Ball Nose	1/4"	SC-1DC	1
	5/16"	SC-2DC	1
	3/8"	SC-3DC	1
	1/2"	SC-5DC	1
Oval	5/8	SC-6DC	1
	1/4"	SE-1DC	1
	3/8"	SE-3DC	1
Tree Radius Nose	1/2"	SE-5DC	1
	1/4"	SF-1DC	1
	3/8"	SF-3DC	1
	1/2"	SF-5DC	1
	5/8	SF-6DC	1
Tree Pointed Nose	3/4	SF-7DC	1
	1/4"	SG-1DC	1
	5/16"	SG-2DC	1
Tree Pointed Nose	3/8"	SG-3DC	1
	1/2"	SG-5DC	1

D. CUT Burr	HEAD ø	CODE	QTY
Flame	5/16"	SH-2DC	1
	1/2"	SH-5DC	1
	5/8	SH-6DC	1
Included Angle	1/4"	SL-1DC	1
	5/16"	SL-2DC	1
	3/8"	SL-3DC	1
Pointed Cone	1/2"	SL-4DC	1
	1/4"	SM-1DC	1
	3/8"	SM-3DC	1
Inverted Cone	3/8"	SM-4DC	1
	1/2"	SM-5DC	1
Inverted Cone	1/4"	SN-1DC	1

AL. CUT Burr	HEAD ø	CODE	QTY
Cylindrical Smooth End	1/4"	SA-1AL	1
	3/8"	SA-3AL	1
Cylindrical Ball Nose	1/4"	SC-1AL	1
	3/8"	SC-3AL	1
Oval	3/8"	SE-3AL	1
	1/4"	SF-1AL	1
Tree Radius Nose	3/8"	SF-3AL	1

Size (mm): 405 W x 410 H x 490 D

Code: **BURR/DIS**



Tough plastic case

**DOUBLE
CUT**

5 PCE Carbide Burr Set

Code: BURRSETRI

SET CONTENTS

DOUBLE CUT Burr	HEAD ø	CODE	SHANK	QTY
Cylindrical Smooth End	1/4"	SA-1DC	1/4"	1
Cylindrical Ball Nose	1/4"	SC-1DC	1/4"	1
Cylindrical Ball Nose	1/2"	SC-5DC	1/4"	1
Tree Radius Nose	1/2"	SF-5DC	1/4"	1
Tree Pointed Nose	5/16"	SG-2DC	1/4"	1

Burr Sets Imperial



BURR SETS IMPERIAL							
No. of Pieces	Head Dia	Kit Contents			Shank	CODE	
4 PCE	3/8"	Double Cut:	SA-3DC Cylindrical Smooth End		1/4" Shank	BURRSET7	
			SB-3DC Cylindrical End Cut				
			SC-3DC Cylindrical Ball Nose				
			SF-3DC Tree Radius Nose				
5 PCE	3/8" & 1/2"	Double Cut:	SB-3DC Cylindrical End Cut		1/4" Shank	BURRSET1	
			SC-3DC Cylindrical Ball Nose				
		SC-5DC Cylindrical Ball Nose					
		SF-3DC Tree Radius Nose					
		SF-5DC Tree Radius Nose					
	1/2"	1/2"	Aluminium Cut:	SA-5AL Cylindrical Smooth End		1/4" Shank	BURRSET5
				SC-5AL Cylindrical Ball Nose			
				SD-5AL Ball			
				SE-5AL Oval			
				SF-5AL Tree Radius Nose			
1/4"	1/4"	Double Cut:	SB-1DC Cylindrical End Cut		1/4" Shank	BURRSET8	
			SC-1DC Cylindrical Ball Nose				
			SD-1DC Ball				
			SF-1DC Tree Radius Nose				
			Aluminium Cut: SC-1AL Cylindrical Ball Nose				
3/8"	3/8"	Double Cut:	SB-3DC Cylindrical End Cut		1/4" Shank	BURRSET9	
			SC-3DC Cylindrical Ball Nose				
			SD-3DC Ball				
			SF-3DC Tree Radius Nose				
			Aluminium Cut: SC-3AL Cylindrical Ball Nose				
1/2"	1/2"	Double Cut:	SB-5DC Cylindrical End Cut		1/4" Shank	BURRSET10	
			SC-5DC Cylindrical Ball Nose				
			SD-5DC Ball				
			SF-5DC Tree Radius Nose				
			Aluminium Cut: SC-5AL Cylindrical Ball Nose				

Special combinations available upon request



Burr Sets Imperial

BURR SETS IMPERIAL					
No. of Pieces	Head Dia	Kit Contents		Shank	CODE
8 PCE	1/4"	Double Cut: SA-1DC Cylindrical Smooth End SC-1DC Cylindrical Ball Nose SD-1DC Ball SE-1DC Oval SF-1DC Tree Radius Nose SG-1DC Tree Pointed Nose SL-1DC Included Angle SM-1DC Pointed Cone		1/4" Shank	BURRSET4
	3/8"	Double Cut: SA-3DC Cylindrical Smooth End SC-3DC Cylindrical Ball Nose SD-3DC Ball SE-3DC Oval SF-3DC Tree Radius Nose SG-3DC Tree Pointed Nose SL-3DC Included Angle SM-4DC Pointed Cone		1/4" Shank	BURRSET2
	1/2"	Double Cut: SA-5DC Cylindrical Smooth End SC-5DC Cylindrical Ball Nose SD-5DC Ball SF-5DC Tree Radius Nose SG-5DC Tree Pointed Nose SH-5DC Flame SL-4DC Included Angle SM-5DC Pointed Cone		1/4" Shank	BURRSET3
9 PCE	1/16", 3/32" & 1/8"	Double Cut: SA-42DC Cylindrical Smooth End SA-43DC Cylindrical Smooth End SC-41DC Cylindrical Ball Nose SC-42DC Cylindrical Ball Nose SD-42DC Ball SE-41DC Oval SF-41DC Tree Radius Nose SG-41DC Tree Pointed Nose SM-43DC Pointed Cone		1/8" Shank	BURRSET11

Special combinations available upon request

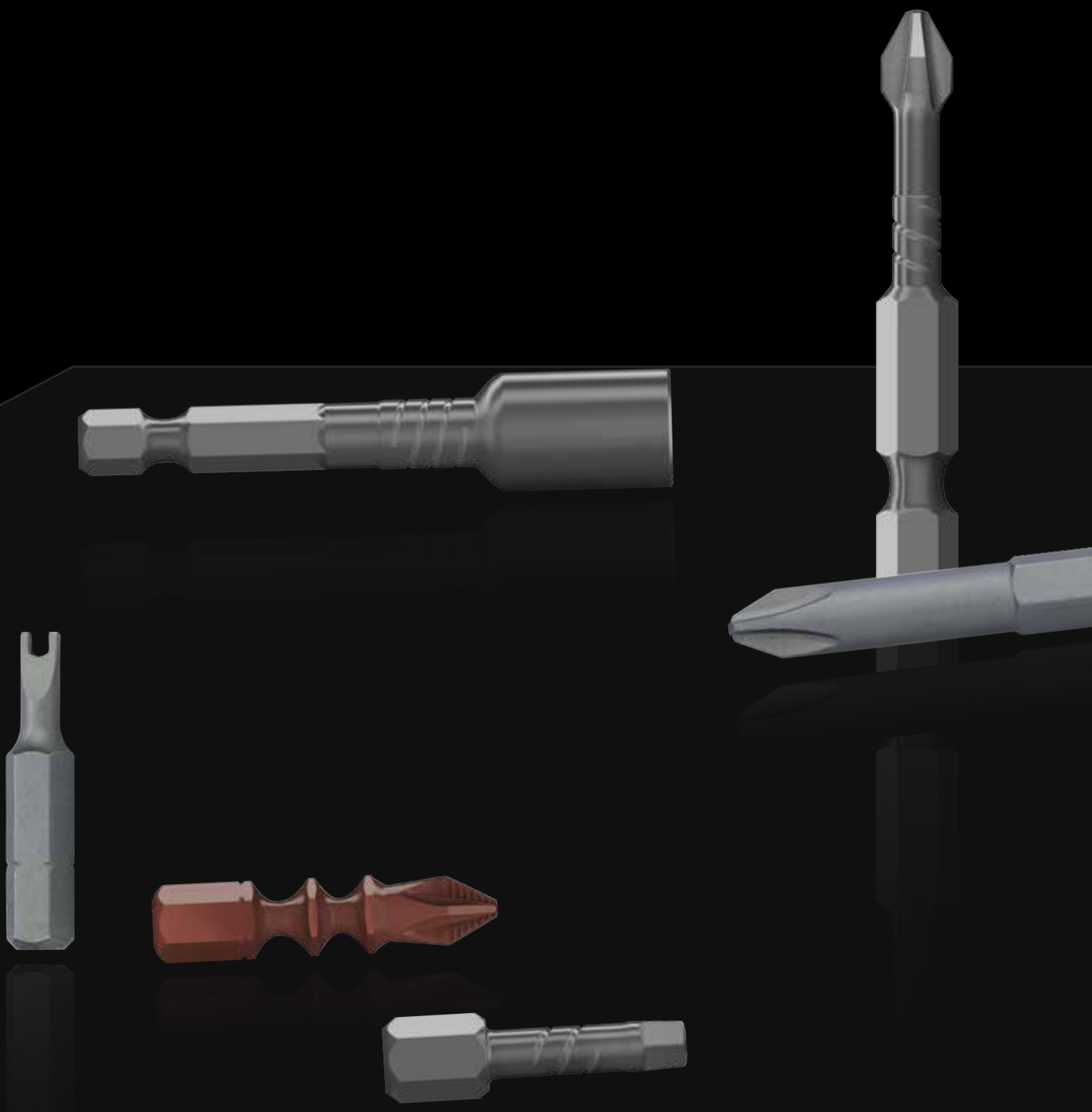

Driver Bits

MAXDRIVE

Phillips®	191
Pozidriv®	191
Square	191
Hex	191
Nutsetter	191

THUNDER ZONE

Phillips®	195
Pozidriv®	195
Square	195
Torx®	195
Hex	196
Slotted	196
Adapter	196
Nutsetter	196
Bit Holders	196
Set	197
Merchandiser	197

ALPHA

Phillips®	202
Phillips® Autofeed	203
Pozidriv®	204
Square	205
Slotted	206
Hex	206
Hex Security	207
Tri-Lobular	207
Pin Security	207
Tri-Wing®	207
Torx®	208
Torx Security	208
Nutsetter	209
Magnetic Socket	209
Adapters	209
Bit Holders	210
Screwdriver Handle	210
Sets	211
Merchandisers	212



Which Driver Bit?

Use the suitable driver bit type to get maximum life out of your driver bit.

Avoiding cam-out will extend the life of driver bits. To minimise cam-out, use the correct size bit to match the fastener and apply the correct pressure to ensure the bit stays engaged.

Registered Trademarks:

ACR, PHILLIPS, POZIDRIV, TORQ-SET and TRI-WING are registered trademarks of the Phillips Screw Company.
TORX and TORX® SECURITY are a registered trademarks of Camcar Division of Textron.

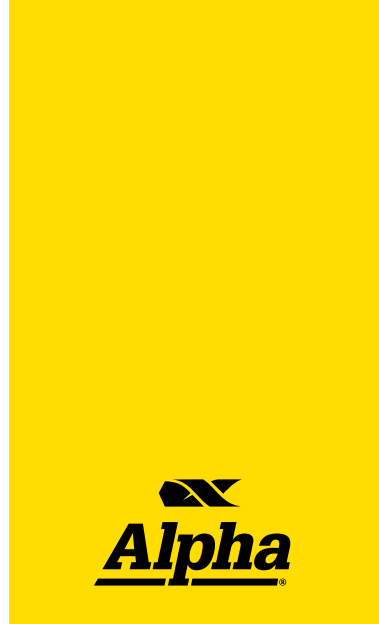
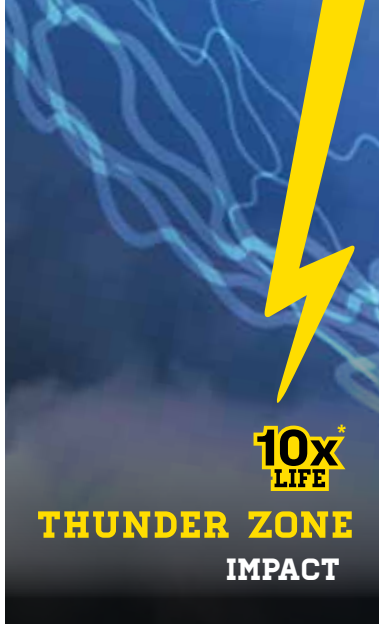
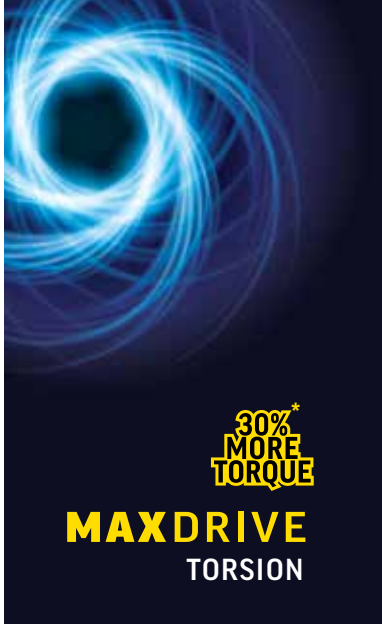

30% MORE TORQUE*
Maximum impact & torque capacity

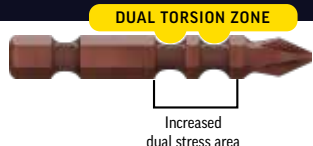

10 x LIFE*
High impact & torque capacity

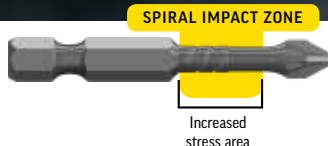

HIGH PERFORMANCE
Regular impact & torsion capacity



Recommended applications
High **IMPACT** & extreme **TORQUE** loads

- Metal to metal fastening when extreme tightening down is required
- Large long gauge screws
- Large gauge self-drilling screws into metal
- Coach screws into hard wood



Suits:
High impact loads with extreme twisting

Recommended applications
High **IMPACT** & high **TORQUE** loads

- Metal to metal fastening when tightening down is required
- Concrete screws
- Long large fasteners
- Screwing down plywood sub-floors



Suits:
High impact loads

Recommended applications
Regular **IMPACT** & Regular **TORQUE** loads

- Drywall
- Fragile materials: soft or thin woods (e.g. cedar), veneers, plastics and acrylics
- Delicate and precise work
- Machine screws in threaded metal
- Fragile screws (e.g. brass)



Suits:
Cordless Drill

Precision machine tip

Compression forged tip - for an ideal fit and to reduce breakage

Optimum full body hardness for longer service life and less wear

Premium quality S2 raw material for superior performance

 Superior magnetism helps the bit grip the screw and prevent cam-out

Specially formulated coating provides greater durability

*than standard bits

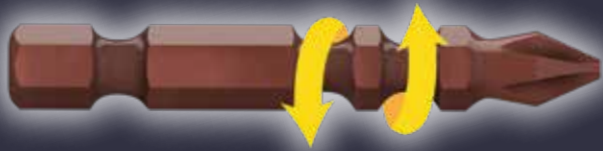

The ultimate DUAL TORSION bit for impact drivers

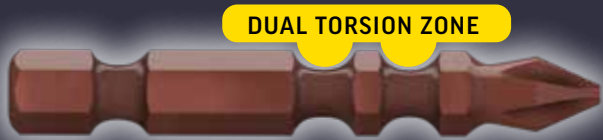

PATENTED DUAL TORSION ZONE

**30%
MORE
TORQUE**
than standard bits



Helps the bit grip the screw and prevent cam-out

- Specially formulated coating provides greater durability
- Premium quality S2 raw material
- Full body hardness for a longer service life
- Precision machine tip for an ideal fit and to reduce breakage

THE RANGE



Phillips



Square



Pozidriv



Hex



Nutsetter



**30%
MORE
TORQUE**

than standard bits

MAXDRIVE



Impact

TORSION Driver Bits

OAL 30 - 50mm
10 per pack



OAL 65 - 100mm
5 per pack



Handi Packs
Suitable for bulk or retail
Hangable plastic pack

Power Bits
1 per card



Insert Bits
2 per card



Carded
Suitable for retail
Hangable card

+ Phillips® ISO 8764



1/4" INSERT +				
Point Size	OAL mm	Body ø mm	HANDI PACKS	CARDED
			10 per pack	2 per card
PH2	30	7.2	PH230ST	CPH230ST*



1/4" POWER +				
Point Size	OAL mm	Body ø mm	HANDI PACKS	CARDED
			10 per pack	1 per card
PH2	50	7.2	PH250ST	CPH250ST*
			5 per pack	1 per card
PH2	75	7.2	PH275ST	CPH275ST*
	100	7.2	PH2100ST	CPH2100ST*
	150	7.2	CPH2150ST	



Double Ended Phillips® - 1/4" Torsion Power Bit

1/4" POWER - DOUBLE ENDED + +				
Point Size	OAL mm	Body ø mm	HANDI PACKS	CARDED
			5 per pack	1 per card
PH2 + PH2	65	7.2	PH265DT	CPH265DT*

*New carded range pending

***** Pozidriv® ISO 8764



1/4" INSERT *				
Point Size	OAL mm	Body ø mm	HANDI PACKS	CARDED
			10 per pack	2 per card
PZ2	30	7.2	PZ230STR	CPZ230STR*



1/4" POWER *				
Point Size	OAL mm	Body ø mm	HANDI PACKS	CARDED
			10 per pack	1 per card
PZ2	50	7.2	PZ250STR	CPZ250STR*

*New carded range pending

□ Square



1/4" INSERT □				
Point Size	OAL mm	Body ø mm	HANDI PACKS	CARDED
			10 per pack	2 per card
SQ2	30	7.2	SQ230ST	CSQ230ST*



1/4" POWER □				
Point Size	OAL mm	Body ø mm	HANDI PACKS	CARDED
			10 per pack	1 per card
SQ2	50	7.2	SQ250ST	CSQ250ST*
			5 per pack	1 per card
SQ2	100	7.2	SQ2100ST	CSQ2100ST*

*New carded range pending

⬡ Hex ISO 2936



1/4" INSERT ⬡				
Point Size	OAL mm	Body ø mm	HANDI PACKS	CARDED
			10 per pack	2 per card
HEX5	30	7.2	HEX530ST	CHEX530ST*



1/4" POWER ⬡				
Point Size	OAL mm	Body ø mm	HANDI PACKS	CARDED
			10 per pack	1 per card
HEX5	50	7.2	HEX550ST	CHEX550ST*
HEX6	50	7.2	HEX650ST*	CHEX650ST*

*New carded range and HEX6 pending

⬢ Nutsetter ISO 2936



5/16" POWER ⬢				
Point Size	OAL mm	Body ø mm	HANDI PACKS	CARDED
			2 per pack	1 per card
5/16"	65	12.7	NS51665ST	CNS51665ST*

*New carded range pending



The ultimate **TORSION** bit for impact drivers

Impact



10x
LIFE

PATENTED SPIRAL IMPACT ZONE

Distributes torque evenly

Thunder Zone impact driver bits feature an engineered spiral torsion zone, distributing the applied impact evenly throughout the torsion zone. Therefore, cam-out is minimised in high impact and torque loads; greatly extending the bit life.



Magnetic

Helps the bit grip the screw and prevent cam-out

- Premium quality S2 raw material
- Full body hardness for a longer service life
- Compression forged tip for an ideal fit and to reduce breakage

THE RANGE



Phillips®

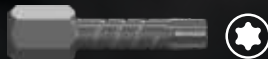

Torx®



Pozidriv®



Hex



Square



Slotted



Adapter



Nutsetter



Bit Holders



10x
LIFE

THUNDER ZONE

IMPACT Driver Bits



Wrapped
Perfect for bulk storage
10 per strip

Insert Bits
2 per card



Carded
Suitable for retail
Hangable card

Power Bits
1 per card



Handi Packs
Suitable for bulk or retail
Hangable plastic pack
Driver Bits: 10 pack
Nutsetters: 5 pack

Phillips®





1/4" INSERT 					
Point Size	OAL mm	Body ø mm	WRAPPED 10 per strip	HANDI PACKS 10 per pack	CARDED 2 per card
PH1	25	7.2	PH125SS	PH125SSH	CPH125SS
PH2	25	7.2	PH225SS	PH225SSH	CPH225SS
PH3	25	7.2	PH325SS	PH325SSH	CPH325SS



1/4" POWER 					
Point Size	OAL mm	Body ø mm	WRAPPED 10 per strip	HANDI PACKS 10 per pack	CARDED 1 per card
PH1	50	7.2	PH150SS	PH150SSH	CPH150SS
	75	7.2	PH175SS	PH175SSH	CPH175SS
	100	7.2	PH1100SS	PH1100SSH	CPH1100SS
	150	7.2	PH1150SS	PH1150SSH	CPH1150SS
PH2	50	7.2	PH250SS	PH250SSH	CPH250SS
	50	7.2	PH250SSR*		
	75	7.2	PH275SS	PH275SSH	CPH275SS
	92	7.2	PH292SS	PH292SSH	
	100	7.2	PH2100SS	PH2100SSH	CPH2100SS
PH3	150	7.2	PH2150SS	PH2150SSH	CPH2150SS
	50	7.2	PH350SS	PH350SSH	CPH350SS

*Ribbed



1/4" POWER - DOUBLE ENDED  					
Point Size	OAL mm	Body ø mm	WRAPPED 10 per strip	HANDI PACKS 10 per pack	CARDED 2 per card
PH2 + PH2	45	7.2	PH245DSS	PH245DSSH	CPH245DSS
	65	7.2	PH265DSS	PH265DSSH	CPH265DSS

Pozidriv®



1/4" INSERT 					
Point Size	OAL mm	Body ø mm	WRAPPED 10 per strip	HANDI PACKS 10 per pack	CARDED 2 per card
PZ1	25	7.2	PZ125SS		
PZ2	25	7.2	PZ225SS	PZ225SSH	CPZ225SS



1/4" POWER 					
Point Size	OAL mm	Body ø mm	WRAPPED 10 per strip	HANDI PACKS 10 per pack	CARDED 1 per card
PZ2	50	7.2	PZ250SS	PZ250SSH	CPZ250SS

Square

IMPACT Driver Bits





1/4" INSERT 					
Point Size	OAL mm	Body ø mm	WRAPPED 10 per strip	HANDI PACKS 10 per pack	CARDED 2 per card
SQ2	25	7.2	SQ225SS	SQ225SSH	CSQ225SS
SQ3	25	7.2	SQ325SS		CSQ325SS



1/4" POWER 					
Point Size	OAL mm	Body ø mm	WRAPPED 10 per strip	HANDI PACKS 10 per pack	CARDED 2 per card
SQ1	50	7.2	SQ150SS	SQ150SSH	CSQ150SS
	50	7.2	SQ250SS	SQ250SSH	CSQ250SS
	75	7.2	SQ275SS	SQ275SSH	CSQ275SS
SQ2	100	7.2	SQ2100SS	SQ2100SSH	CSQ2100SS
	150	7.2	SQ2150SS	SQ2150SSH	CSQ2150SS
SQ3	50	7.2	SQ350SS	SQ350SSH	CSQ350SS
	100	7.2	SQ3100SS		CSQ3100SS
	150	7.2	SQ3150SS		



1/4" POWER - DOUBLE ENDED  					
Point Size	OAL mm	Body ø mm	WRAPPED 10 per strip	HANDI PACKS 10 per pack	CARDED 2 per card
SQ2 + SQ2	65	7.2	SQ265DSS	SQ265DSSH	CSQ265DSS

Torx®



1/4" INSERT 					
Point Size	OAL mm	Body ø mm	WRAPPED 10 per strip		
T25	25	7.2	TX2525SS		



1/4" POWER 					
Point Size	OAL mm	Body ø mm	WRAPPED 10 per strip	HANDI PACKS 10 per pack	CARDED 1 per card
T10	75	7.2	TX1075SS		
T15	50	7.2	TX1550SS		CTX1550SS
T20	50	7.2	TX2050SS	TX2050SSH	CTX2050SS
	75	7.2	TX2075SS		
T25	50	7.2	TX2550SS		CTX2550SS
T30	50	7.2	TX3050SS	TX3050SSH	CTX3050SS
	75	7.2	TX3075SS		
T40	50	7.2	TX4050SS	TX4050SSH	CTX4050SS

IMPACT Driver Bits

Hex ISO 2936



1/4" INSERT					
Point Size	OAL mm	Body ø mm	WRAPPED 10 per strip	HANDI PACKS 10 per pack	CARDED 2 per card
HEX5	25	7.2	HEX525SS	HEX525SSH	CHEX525SS



1/4" POWER					
Point Size	OAL mm	Body ø mm	WRAPPED 10 per strip	HANDI PACKS 10 per pack	CARDED 1 per card
HEX4	50	7.2	HEX450SS	HEX450SSH	CHEX450SS
HEX5	50	7.2	HEX550SS	HEX550SSH	CHEX550SS
	75	7.2	HEX575SS	HEX575SSH	CHEX575SS
HEX6	60	7.2	HEX660SS	HEX660SSH	CHEX660SS



1/4" POWER - DOUBLE ENDED					
Point Size	OAL mm	Body ø mm	WRAPPED 10 per strip		
HEX5 + HEX5	60	7.2	HEX560DSS		

Slotted ISO 2380



1/4" INSERT					
Point Size	OAL mm	Body ø mm	WRAPPED 10 per strip	HANDI PACKS 10 per pack	CARDED 2 per card
SL6	25	7.2	SL625SS	SL625SSH	CSL625SS

Adapter

Hex to Square



Adaptor - 1/4" Hex Drive to 1/4" Square Drive

1/4" HEX TO SQUARE ADAPTORS					
Point Size	OAL mm	Body ø mm	WRAPPED 10 per strip		
1/4"	75	8	ADP14-75SS		

Nutsetter ISO 2936



1/4" MAGNETIC NUTSETTER					
Point Size	OAL mm	Max ø mm	WRAPPED 10 per strip	HANDI PACKS 5 per pack	CARDED 1 per card
1/4"	42	11	NS1442SS	NS1442SSH	CNS1442SS
	65	11	NS1465SS	NS1465SSH	CNS1465SS

5/16" MAGNETIC NUTSETTER					
Point Size	OAL mm	Max ø mm	WRAPPED 10 per strip	HANDI PACKS 5 per pack	CARDED 1 per card
5/16"	42	13	NS51642SS	NS51642SSH	CNS51642SS
	65	13	NS51665SS	NS51665SSH	CNS51665SS
	100	13	NS516100SS		
	150	13	NS516150SS		

3/8" MAGNETIC NUTSETTER					
Point Size	OAL mm	Max ø mm	WRAPPED 10 per strip	HANDI PACKS 5 per pack	CARDED 1 per card
3/8"	42	14.6	NS3842SS	NS3842SSH	CNS3842SS
	65	14.6	NS3865SS	NS3865SSH	CNS3865SS

Bit Holders



Magnetic Bit Holder - 1/4" Impact Bit

1/4" BIT HOLDER					
Point Size	OAL mm	Body ø mm	WRAPPED 10 per strip		CARDED 1 per card
1/4"	75	11	MBHC75SS		CMBHC75SS
	150	11	MBHC150SS		CMBHC150SS



Magnetic Bit Holder - 1/4" Impact Bit with spring loaded quick release

1/4" BIT HOLDER - QUICK RELEASE					
Point Size	OAL mm	Body ø mm	WRAPPED 10 per strip		CARDED 1 per card
1/4"	75	13.6	MBHQR75SS		CMBHQR75SS

10 PCE THUNDER ZONE Set

DESCRIPTION	SIZE	CODE	QTY
Phillips® Power Bits	PH2 x 50	PH250SS	4
Square Power Bits	SQ2 x 50	SQ150SS	1
	SQ3 x 50	SQ250SS	1
Hex Power Bits	HEX5 x 50	HEX550SS	2
Nutsetters	5/16" x 65	NS51665SS	1
	3/8" x 65	NS3865SS	1

Code: TBS10

10
ITEMS



THUNDER ZONE Counter Merchandiser

Guaranteed to increase
Alpha driver bit sales

THE
3 BEST
SELLERS

DESCRIPTION	SIZE	CODE	QTY
Phillips® Power Bits Handi Packs	PH2 x 50	PH250SSH	8
Square Power Bits Handi Packs	SQ2 x 50	SQ250SSH	8
10 PCE Set	10 Pieces (details above)	TBS10	16

Code: COUNT-TZ



Compact video player
with motion detection.
Hassle free – just plug in!
Scan to watch the video

THUNDER ZONE

Large Bulk Merchandiser

- Pull out stock drawer runs on ball bearing slides, providing easy access
- Clearly labelled compartments
- Clear fold up lockable perspex lid
- Full product identification and barcoding on rear
- Compact footprint

Code: LGE/BIT-TZ

Size (mm): 405 W x 410 H x 490 D

25 SKUS
405 items



Merchandiser contains individually wrapped bits with item code, barcode and branding

DESCRIPTION	ITEM	CODE	QTY
Phillips® Insert Bit	PH2 x 25	PH225SS	30
	PH1 x 50	PH150SS	10
	PH2 x 50	PH250SS	30
Phillips® Power Bit	PH2 x 75	PH275SS	30
	PH2 x 100	PH2100SS	20
	PH2 x 150	PH2150SS	10
	PH2 x 45	PH245DSS	20
Phillips® Double Ended	PH2 x 65	PH265DSS	20
Pozidriv® Insert Bit	PZ2 x 25	PZ225SS	20
Pozidriv® Power Bit	PZ2 x 50	PZ250SS	20
	SQ1 x 50	SQ150SS	10
Square Power Bit	SQ2 x 50	SQ250SS	10
	SQ3 x 50	SQ350SS	10
	Hex Insert Bit	HEX5 x 25	HEX525SS

DESCRIPTION	ITEM	CODE	QTY
Slotted Insert Bit	SL6 x 25	SL625SS	20
	T20 x 50	TX2050SS	10
Torx® Power Bit	T30 x 50	TX3050SS	10
	1/4" x 42	NS1442SS	10
Nutsetters	5/16" x 42	NS51642SS	20
	5/16" x 65	NS51665SS	20
	3/8" x 42	NS3842SS	10
	3/8" x 65	NS3865SS	10
Adapter - Hex to Square	1/4" - 1/4" x 75	ADP14-75S	20
Magnetic Bit Holder	Quick Release 1/4" x 75	MBHQ75SS	5
	C Ring 1/4" x 75	MBHC75SS	10

THUNDER ZONE Maxi Bulk Merchandiser



34 SKUS
660 items

- Pull out stock drawers run on ball bearing slides, providing easy access
- Clearly labelled compartments
- Clear fold-up perspex lid
- Combination lock supplied for security
- Full product identification and barcoding on back of merchandiser

Code: MAX/BIT-TZ

Size (mm): 405 W x 580 H x 480 D

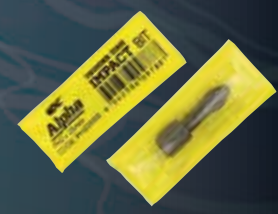

Merchandiser contains individually wrapped bits with item code, barcode and branding

DESCRIPTION	ITEM	CODE	QTY
Phillips® Insert Bit	PH2 x 25	PH225SS	30
	PH1 x 50	PH150SS	20
	PH2 x 50	PH250SS	50
Phillips® Power Bit	PH2 x 75	PH275SS	30
	PH2 x 100	PH2100SS	20
	PH2 x 150	PH2150SS	20
	PH3 x 50	PH350SS	20
Phillips® Double Ended	PH2 x 65	PH265DSS	20
Pozidriv® Power Bit	PZ2 x 50	PZ250SS	20
Square Insert Bit	SQ2 x 25	SQ225SS	20
	SQ1 x 50	SQ150SS	20
Square Power Bit	SQ2 x 50	SQ250SS	20
	SQ2 x 100	SQ2100SS	20
	SQ3 x 50	SQ350SS	20
Square Double Ended	SQ2 x 65	SQ265DSS	20
	HEX4 x 50	HEX450SS	20
Hex Power Bit	HEX5 x 50	HEX550SS	20
	HEX6 x 60	HEX660SS	20

DESCRIPTION	ITEM	CODE	QTY	
Slotted Insert Bit	SL6 x 25	SL625SS	20	
	T15 x 50	TX1550SS	20	
	T20 x 50	TX2050SS	20	
Torx® Power Bit	T25 x 50	TX2550SS	20	
	T30 x 50	TX3050SS	20	
	T40 x 50	TX4050SS	20	
	1/4" x 42	NS1442SS	10	
Nutsetters	1/4" x 65	NS1465SS	10	
	5/16" x 42	NS51642SS	20	
	5/16" x 65	NS51665SS	20	
	3/8" x 42	NS3842SS	10	
Adapter - Hex to Square	3/8" x 65	NS3865SS	10	
	1/4" - 1/4" x 75	ADP14-75SS	20	
Magnetic Bit Holder	Quick Release	1/4" x 75	MBHQR75SS	10
	C Ring	1/4" x 75	MBHC75SS	10
		1/4" x 150	MBHC150SS	10



Wrapped
Perfect for bulk storage
10 per strip



Handi Packs
Suitable for bulk or retail
Convenient plastic pack
Driver Bits: 10 pack
Drywall Phillips: 4 pack
Nutsetters: 5 pack

Insert Bits
2 per card



Power Bits
1 per card



Carded
Suitable for retail
Hangable card

Insert Bits

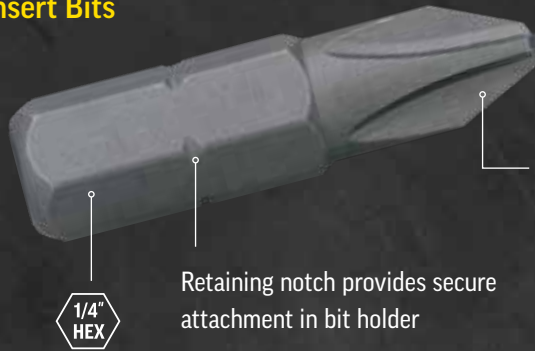

1/4" HEX

Retaining notch provides secure attachment in bit holder



Superior magnetism helps the bit grip the screw and prevent cam-out

Power Bits

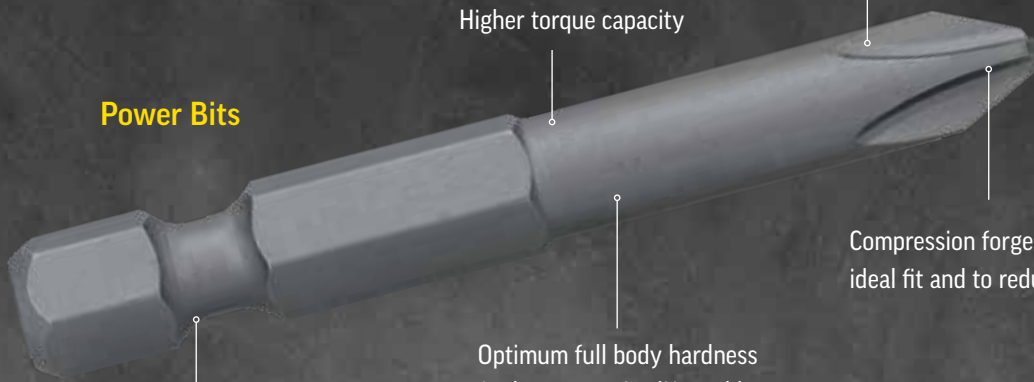

1/4" QUICK CHANGE

Higher torque capacity

Optimum full body hardness for longer service life and less wear



Superior magnetism helps the bit grip the screw and prevent cam-out

Compression forged tip, for an ideal fit and to reduce breakage

THE RANGE

The extensive Alpha range includes both Phillips® and Pozidriv® ribbed design which provide extra grip

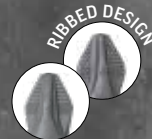

Phillips®



Slotted



Tri-Wing®



Bit Holders



Drywall Phillips®



Hex & Hex Security



Torx® & Torx® Security



Magnetic Socket



Pozidriv®



Tri-Lobular

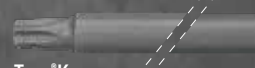

Torx® Key & Torx® Key Security



Adapters



Square



Pin Security



Nutsetter

...and a selection of Insert and Security Bit Sets

Phillips® Driver Bits



Phillips®
1/4" Insert Bit

1/4" INSERT

Point Size	OAL mm	Body ø mm	WRAPPED 10 per strip	HANDI PACKS 10 per pack	CARDED 2 per card
PH0	25	4.5	PH025S		
PH1	25	4.5	PH125S		CPH125S
PH2	25	6.0	PH225S	PH225SH*	CPH225S
	30	6.0	PH230S		
	38	6.0	PH238S		
PH3	25	6.0	PH325S	PH325SH	CPH325S
PH4	25	6.0	PH425S		

*PH2 available in handi packs of 20 & 100

Point Size	OAL mm	Body ø mm	Pack QTY	HANDI PACKS
PH2	25	6.0	20	PH225SHXL
	25	6.0	100	PH225SHXXL



Phillips®
1/4" Power Bit

1/4" POWER

Point Size	OAL mm	Body ø mm	WRAPPED 10 per strip	HANDI PACKS 10 per pack	CARDED 1 per card
PH0	75	4.5	PH075S		
PH1	50	4.5	PH150S	PH150SH	CPH150S
	75	4.5	PH175S		
	92	4.5	PH192S		
	100	4.5	PH1100S		
	150	4.5	PH1150S		
PH2	50	6.0	PH250S	PH250SH	CPH250S
	65	6.0	PH265S	PH265SH	
	75	6.0	PH275S	PH275SH	CPH275S
	92	6.0	PH292S	PH292SH	CPH292S
	100	6.0	PH2100S	PH2100SH	CPH2100S
	150	6.0	PH2150S	PH2150SH	CPH2150S
	200	6.0	PH2200S		
	250	6.0	PH2250S		
PH3	50	6.0	PH350S	PH350SH	CPH350S
	75	6.0	PH375S		
	100	6.0	PH3100S		
	150	6.0	PH3150S		



Double Ended Phillips®
1/4" Power Bit

1/4" POWER - DOUBLE ENDED

Point Size	OAL mm	Body ø mm	WRAPPED 10 per strip	HANDI PACKS 10 per pack	CARDED 1 per card
PH1 + PH1	45	7.2	PH145D		
	75	7.2	PH175D		
PH2 + PH2	45	7.2	PH245D	PH245DH	CPH245D
	65	7.2	PH265D	PH265DH	CPH265D
	75	7.2	PH275D	PH275DH	
	100	7.2	PH2100D	PH2100DH	CPH2100D
	150	7.2	PH2150D	PH2150DH	
	200	7.2	PH2200D		
	300	7.2	PH2300D		
400	7.2	PH2400D			
PH3 + PH3	65	7.2	PH365D		



Double Ended Phillips® & Slotted
1/4" Power Bit

1/4" POWER - DOUBLE ENDED

Point Size	OAL mm	Body ø mm	WRAPPED 10 per strip	CARDED 1 per card
PH1 + SL4	45	7.2	PH1SL445D	
PH2 + SL5	45	7.2		CPH2SL545D
PH2 + SL6	45	7.2	PH2SL645D	
PH2 + SL8	60	7.2	PH2SL860D	



Double Ended Phillips® & Square
1/4" Power Bit

1/4" POWER - DOUBLE ENDED

Point Size	OAL mm	Body ø mm	WRAPPED 10 per strip
PH2 + SQ2	50	10.0	PH2SQ250D
	89	10.0	PH2SQ289D



Drywall Phillips®
1/4" Insert Bit

1/4" INSERT - DRYWALL BITS

Point Size	OAL mm	Body ø mm	WRAPPED 10 per strip	HANDI PACKS 4 per pack	CARDED 2 per card
PH2	25	14	PH225DW	PH225DWH	CPH225DW

Phillips® ISO 8764



Reduced Head Phillips® 1/4" Insert Bit



For poorly stamped screws

1/4" INSERT - REDUCED HEAD				
Point Size	OAL mm	Body ø mm	WRAPPED 10 per strip	HANDI PACKS 10 per pack
PH R2	25	5.0	PHR225S	PHR225SH



Reduced Head Phillips® 1/4" Power Bit

1/4" POWER - REDUCED HEAD			
Point Size	OAL mm	Body ø mm	WRAPPED 10 per strip
PH R2	50	5.0	PHR250S
	89	5.0	PHR289S



Phillips® 5/16" Impact Bit

5/16" IMPACT

5/16" IMPACT			
Point Size	OAL mm	Body ø mm	BULK 10 per pack
PH1	32	8.0	PH132I
	32	8.0	PH232I
PH2	76	8.0	PH276I
	32	8.0	PH332I
PH3	76	8.0	PH376I
	32	8.0	PH432I
PH4	76	8.0	PH476I



Ribbed Phillips® 1/4" Insert Bit



Extra grip prevents cam-out

1/4" INSERT - RIBBED					
Point Size	OAL mm	Body ø mm	WRAPPED 10 per strip	HANDI PACKS 10 per pack	CARDED 2 per card
PH1	25	4.0	PH125SR		
PH2	25	6.0	PH225SR	PH225SRH	CPH225SR



Ribbed Phillips® 1/4" Power Bit

1/4" POWER - RIBBED					
Point Size	OAL mm	Body ø mm	WRAPPED 10 per strip	HANDI PACKS 10 per pack	CARDED 1 per card
PH2	50	6.0	PH250SR	PH250SRH	CPH250SR
	75	6.0	PH275SR	PH275SRH	CPH275SR
	100	6.0	PH2100SR	PH2100SRH	CPH2100SR
PH3	150	6.0	PH2150SR		CPH2150SR
	50	6.0	PH350SR		

Phillips® ISO 8764

Autofeed Screwdriver Bits

1/4" Quick Change Shank



- Precision head design, manufactured to highest standard - ISO 8764
- Magnetised
- Forged from premium S2 steel with full body (58-62HRC) hardening for optimum performance and longer life

1/4" AUTOFEED SCREWDRIVER BITS - MAKITA, HILTI & HITACHI				
Point Size	OAL mm	Body ø mm	Suits	CARDED 4 per card
PH2	116	4.75	Hilti SMD57	CPH2116S
	117	4.75	Makita 6831	CPH2117S
	122	5.00	Makita BFR440	CPH2122S
	132	5.00	Makita DFR450	CPH2132S
			Makita 6835D, 6833 & 6836	
	146	5.00	Makita 6834	CPH2146S
	152	4.75	Makita 240 Volt Hitachi W4YE & W4YF	CPH2152S
	157	5.00	Makita BFR550	CPH2157S
	164	5.00	Makita 6842 & 6843	CPH2164S
			Makita BFR540R & BFR550R	

Carded Suitable for retail 4 per card

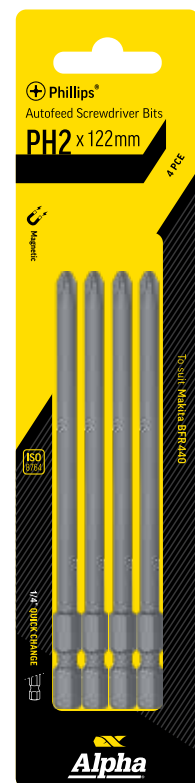

Alpha

Pozidriv® Driver Bits



Pozidriv®
1/4" Insert Bit

1/4" INSERT

Point Size	OAL mm	Body ø mm	WRAPPED 10 per strip	HANDI PACKS 10 per pack	CARDED 2 per card
PZ1	25	4.5			CPZ125S**
PZ2	25	6.0	PZ225S	PZ225SH*	CPZ225S
PZ3	25	6.0	PZ325S		CPZ325S
PZ4	32	6.0	PZ432S		

*PZ2 available in a handi pack of 100 **While stocks last

Point Size	OAL mm	Body ø mm	Pack QTY	HANDI PACKS
PZ2	25	6.0	100	PZ225SHXXL



Pozidriv®
1/4" Power Bit

1/4" POWER

Point Size	OAL mm	Body ø mm	WRAPPED 10 per strip	HANDI PACKS 10 per pack	CARDED 1 per card
PZ1	50	4.5	PZ150S		CPZ150S
	75	4.5	PZ175S		
	150	4.5	PZ1150S		
PZ2	50	6.0	PZ250S	PZ250SH	CPZ250S
	75	6.0	PZ275S		
	89	6.0	PZ289S		
	120	6.0	PZ2120S		
	150	6.0	PZ2150S		CPZ2150S
PZ3	50	6.0	PZ350S		CPZ350S
	75	6.0	PZ375S		
	89	6.0	PZ389S		



Pozidriv®
5/16" Impact Bit

5/16" IMPACT

5/16" IMPACT

Point Size	OAL mm	Body ø mm	BULK 10 per pack
PZ1	32	8.0	PZ132I
PZ2	32	8.0	PZ232I
	76	8.0	PZ276I



Double Ended Pozidriv®
1/4" Power Bit

1/4" POWER - DOUBLE ENDED

Point Size	OAL mm	Body ø mm	WRAPPED 10 per strip	CARDED 1 per card
PZ1 + PZ1	65	7.2	PZ165D	
PZ2 + PZ2	45	7.2	PZ245D	CPZ245D
	65	7.2	PZ265D	
	75	7.2	PZ275D	



Double Ended Pozidriv® & Square
1/4" Power Bit

1/4" POWER - DOUBLE ENDED

Point Size	OAL mm	Body ø mm	WRAPPED 10 per strip	CARDED 1 per card
PZ2 + SQ2	50	7.2	PZ2SQ250D	



Reduced Head Pozidriv®
1/4" Insert Bit



For poorly stamped screws

1/4" INSERT - REDUCED HEAD

Point Size	OAL mm	Body ø mm	WRAPPED 10 per strip
PZ R1	25	4.0	PZR125S



Reduced Head Pozidriv® - 1/4" Power Bit

1/4" INSERT - REDUCED HEAD

Point Size	OAL mm	Body ø mm	WRAPPED 10 per strip
PZ R2	75	4.0	PZR275S



Ribbed Pozidriv®
1/4" Insert Bit



Extra grip prevents cam-out

1/4" INSERT - RIBBED

Point Size	OAL mm	Body ø mm	WRAPPED 10 per strip
PZ2	25	6.0	PZ225SR



Ribbed Pozidriv®
1/4" Power Bit

1/4" POWER - RIBBED

Point Size	OAL mm	Body ø mm	WRAPPED 10 per strip
PZ2	50	6.0	PZ250SR

□ Square



Square
1/4" Insert Bit

1/4" INSERT					
Point Size	OAL mm	Body ø mm	WRAPPED 10 per strip	HANDI PACKS 10 per pack	CARDED 2 per card
SQ0	25	5.0	SQ025S		
SQ1	25	5.0	SQ125S		CSQ125S
SQ2	25	6.0	SQ225S	SQ225SH	CSQ225S
SQ3	25	6.0	SQ325S		CSQ325S



Square
1/4" Power Bit

1/4" POWER					
Point Size	OAL mm	Body ø mm	WRAPPED 10 per strip	HANDI PACKS 10 per pack	CARDED 1 per card
SQ0	50	5.0	SQ050S		
	89	5.0	SQ089S		
SQ1	50	5.0	SQ150S	SQ150SH	CSQ150S
	75	5.0	SQ175S		
	90	5.0	SQ190S		
	100	5.0	SQ1100S		
SQ2	150	5.0	SQ1150S		
	50	6.0	SQ250S	SQ250SH	CSQ250S
	75	6.0	SQ275S	SQ275SH	CSQ275S
	90	6.0	SQ290S		
	100	6.0	SQ2100S	SQ2100SH	CSQ2100S
SQ3	132	6.0	SQ2132S		
	150	6.0	SQ2150S	SQ2150SH	CSQ2150S
	50	6.0	SQ350S	SQ350SH	CSQ350S
	75	6.0	SQ375S		
	100	6.0	SQ3100S		
	150	6.0	SQ3150S		



Double Ended Square
1/4" Power Bit

1/4" POWER - DOUBLE ENDED			
Point Size	OAL mm	Body ø mm	WRAPPED 10 per strip
SQ2 + SQ2	45	7.2	SQ245D
	185	7.2	SQ2185D



Double Ended
Square & Phillips®
1/4" Power Bit

1/4" POWER - DOUBLE ENDED				
Point Size	OAL mm	Body ø mm	SQ Screw size #	WRAPPED 10 per strip
SQ2 + PH2	50	7.2	8 - 10	PH2SQ250D
	89	7.2	8 - 10	PH2SQ289D
SQ2 + PZ2	50	7.2	8 - 10	PZ2SQ250D

Point Conversions
 SQ0 = 1.8mm
 SQ1 = 2.4mm
 SQ2 = 3.0mm
 SQ3 = 3.4mm

□ Square Security



Post Hole Security
Square
1/4" Power Bit

1/4" POWER - POST HOLE SECURITY			
Point Size	OAL mm	Body ø mm	WRAPPED 10 per strip
SQ2	50	6.0	SQSE250S

Driver Bits

Slotted ISO 2380



1/4" INSERT				
Point Size	OAL mm	Screw size mm	WRAPPED 10 per strip	CARDED 2 per card
SL4	25	3 - 4	SL425S	CSL425S
SL5	25	5 - 6	SL525S	CSL525S
SL6	25	6 - 10	SL625S	CSL625S
SL10	25	14 - 16	SL1025S	



1/4" POWER BITS				
Point Size	OAL mm	Screw size mm	WRAPPED 10 per strip	CARDED 1 per card
SL3	50	1 - 2	SL350S	CSL350S
	70	1 - 2	SL370S	
SL4	50	3 - 4	SL450S	CSL450S
SL5	50	5 - 6	SL550S	CSL550S
	75	5 - 6	SL575S	
SL6	50	6 - 10	SL650S	CSL650S
SL8	50	12 - 14	SL850S	CSL850S

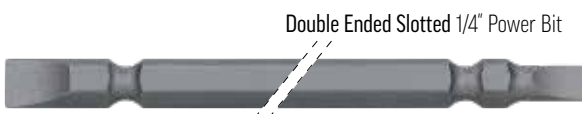

1/4" POWER - DOUBLE ENDED				
Point Size	OAL mm	Screw size mm	WRAPPED 10 per strip	CARDED 1 per card
SL5 + SL7	100	5 - 12	SL5SL7100D	



1/4" POWER - DOUBLE ENDED				
Point Size	OAL mm	Screw size mm	WRAPPED 10 per strip	CARDED 1 per card
PH1 + SL4	45	3 - 4	PH1SL445D	
PH2 + SL5	45	5 - 6		CPH2SL545D
PH2 + SL6	45	6 - 10	PH2SL645D	
PH2 + SL8	60	12 - 14	PH2SL860D	



5/16" IMPACT			
Point Size	OAL mm	Screw size mm	BULK 10 per pack
SL8	32	12 - 14	SL832I
SL10	36	14 - 16	SL1036I
SL12	36	16 - 18	SL1236I

Hex ISO 2936



1/4" INSERT					
Point Size	OAL mm	Body ø mm	WRAPPED 10 per strip	HANDI PACKS 10 per pack	CARDED 2 per card
HEX2	25	7.2	HEX225S		
HEX2.5	25	7.2	HEX2525S		
HEX3	30	7.2	HEX330S		
HEX4	30	7.2	HEX430S		
HEX5	25	7.2			CHEX525S
HEX5	30	7.2	HEX530S	HEX530SH	
HEX6	32	7.2	HEX632S		
HEX8	32	9.0	HEX832S		
HEX10	32	11.3	HEX1032S		
HEX 1/8"	25	7.2	HEX1825S		



1/4" POWER					
Point Size	OAL mm	Body ø mm	WRAPPED 10 per strip	HANDI PACKS 10 per pack	CARDED 1 per card
HEX2.5	50	7.2	HEX2550S		
HEX3	50	7.2	HEX350S		
HEX4	50	7.2	HEX450S		
HEX5	50	7.2	HEX550S	HEX550SH	CHEX550S
	75	7.2	HEX575S		CHEX575S
	100	7.2	HEX5100S		CHEX5100S
HEX5	150	7.2	HEX5150S		
	HEX8	65	8.0	HEX865S	



1/4" POWER - BALL END					
Point Size	OAL mm	Body ø mm		HANDI PACKS 10 per pack	
HEX5	50	7.2		HEX5BE50H	
	150	7.2		HEX5BE150H	
HEX6	50	7.2		HEX6BE50H	
	150	7.2		HEX6BE150H	

Hex Security



Hex Security
1/4" Insert Bit

1/4" INSERT - METRIC			
Point Size	OAL mm	Body ø mm	WRAPPED 10 per strip
2.0	25	7.2	HEXSE225
2.5	25	7.2	HEXSE2525
3.0	25	7.2	HEXSE325
4.0	25	7.2	HEXSE425
5.0	25	7.2	HEXSE525
6.0	25	7.2	HEXSE625

1/4" INSERT - IMPERIAL			
Point Size	OAL mm	Body ø mm	WRAPPED 10 per strip
3/32"	32	7.2	HEXSE332
1/8"	32	7.2	HEXSE18
5/32"	32	7.2	HEXSE532
3/16"	32	7.2	HEXSE316
7/32"	32	7.2	HEXSE732

Tri-Lobular



Tri-Lobular
1/4" Insert Bit

1/4" INSERT			
Point Size	OAL mm	Body ø mm	WRAPPED 10 per strip
TRILOB	25	4	TRI-LOB

Tri-Lobular® 1/4" Power Bit



1/4" POWER			
Point Size	OAL mm	Body ø mm	WRAPPED 10 per strip
TRILOB	100	6	TRILOB100

Pin Security



Pin Security
1/4" Insert Bit

1/4" INSERT				
Size	OAL mm	Point ø mm	Body ø mm	WRAPPED 10 per strip
PIN4	32	3.6	7.2	PIN432S
PIN6	32	4	7.2	PIN632S
PIN8	32	5.3	7.2	PIN832S
PIN10	25	6.1	7.2	PIN1025S
PIN12	25	7.2	7.2	PIN1225S
PIN14	32	8	7.2	PIN1432S



Tri-Wing®



Tri-Wing®
1/4" Insert Bit

1/4" INSERT			
Point Size	OAL mm	Body ø mm	WRAPPED 10 per strip
1	25	4.4	TRI125S
3	25	4.6	TRI325S
4	25	5.7	TRI425S
5	25	6.3	TRI525S

Torx®



Torx®
1/4" Insert Bit

1/4" INSERT			
Point Size	OAL mm	Point ø mm	WRAPPED 10 per strip
T8	25	2.2	TX825S
T10	25	2.7	TX1025S
T15	25	3.3	TX1525S
T20	25	3.8	TX2025S
T25	25	4.4	TX2525S
T27	25	5.0	TX2725S
T30	25	5.5	TX3025S
T40	25	6.6	TX4025S



Torx® 1/4" Power Bit

1/4" POWER			
Point Size	OAL mm	Point ø mm	WRAPPED 10 per strip
T10	75	2.7	TX1075S
T15	50	3.3	TX1550S
T20	50	3.8	TX2050S
T20	75	3.8	TX2075S
T25	50	4.4	TX2550S
T30	50	5.5	TX3050S
	75	5.5	TX3075S
T40	100	5.5	TX30100S
	50	6.6	TX4050S

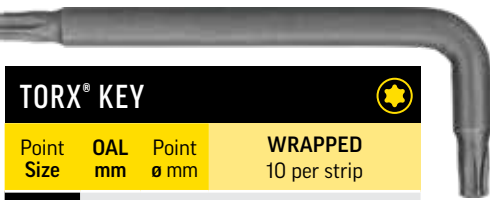

Torx® Key

TORX® KEY			
Point Size	OAL mm	Point ø mm	WRAPPED 10 per strip
T8	51	2.2	ALKTX8
T10	51	2.7	ALKTX10
T15	58	3.3	ALKTX15
T20	74	3.8	ALKTX20
T25	74	4.4	ALKTX25
T40	86	6.6	ALKTX40
T45	86	7.9	ALKTX45
T50	105	8.7	ALKTX50
T55	115	10.8	ALKTX55

Torx® Security



Torx® Security
1/4" Insert Bit

1/4" INSERT - SECURITY			
Point Size	OAL mm	Point ø mm	WRAPPED 10 per strip
T8	25	2.2	TXSE825
T10	25	2.7	TXSE1025
T15	25	3.3	TXSE1525
T20	25	3.8	TXSE2025
T25	25	4.4	TXSE2525
T27	25	5.0	TXSE2725
T30	25	5.5	TXSE3025
T40	25	6.6	TXSE4025
T45	25	7.9	TXSE4525
T50	25	8.7	TXSE5025



Torx® Security 1/4" Power Bit

1/4" POWER - SECURITY			
Point Size	OAL mm	Point ø mm	WRAPPED 10 per strip
T10	75	2.7	TXSE1075S



Torx® Security 5 Pin
1/4" Insert Bit

1/4" INSERT - SECURITY 5 PIN			
Point Size	OAL mm	Point ø mm	WRAPPED 10 per strip
5T30	25	5.5	5TXSE3025

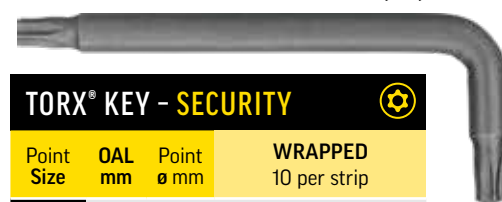

Torx® Security Key

TORX® KEY - SECURITY			
Point Size	OAL mm	Point ø mm	WRAPPED 10 per strip
T25	74	4.4	ALKTXSE25
T27	74	5.0	ALKTXSE27
T30	74	5.5	ALKTXSE30
T45	86	7.9	ALKTXSE45

Nutsetter ISO 2936



Magnetic Nutsetter
1/4" Hex Drive

1/4" MAGNETIC NUTSETTER - METRIC				
Point Size	OAL mm	Max ø mm	WRAPPED	
7.0	65	11.9	NS765	
8.0	65	12.7	NS865	
10.0	65	14.9	NS1065	
12.0	55	17.1	NS1255	
13.0	55	18.9	NS1355	

1/4" MAGNETIC NUTSETTER - IMPERIAL					
Point Size	OAL mm	Max ø mm	WRAPPED	HANDI PACKS	CARDED
1/4"	42	11	NS1442	NS1442H	CNS1442
	65	11	NS1465	NS1465H	CNS1465
	100	11	NS14100		
5/16"	42	12.8	NS51642	NS51642H	CNS51642
	65	12.8	NS51665	NS51665H	CNS51665
	100	12.8	NS516100		
	150	12.8	NS516150		CNS516150
	200	12.8	NS516200		CNS516200
	300	12.8	NS516300		
3/8"	42	14.6	NS3842	NS3842H	CNS3842
	65	14.6	NS3865	NS3865H	CNS3865
	150	14.6	NS38150		CNS38150
7/16"	65	15.6	NS71665		
9/16"	65	20.1	NS91665		

Magnetic Socket



Square to Hex Drive
Magnetic Sockets

1/4" DRIVE SQUARE- METRIC			
Point Size	OAL mm	Body ø mm	WRAPPED
7.0	22.2	11.9	MS722
8.0	25.4	12.7	MS825

3/8" DRIVE SQUARE- IMPERIAL			
Point Size	OAL mm	Body ø mm	WRAPPED
5/16"	32.0	13	MS51638

Adapter

Hex to Square



Adaptor - 1/4" Hex Drive
to 1/4" Square Drive

1/4" HEX TO SQUARE ADAPTOR			
Square inches	OAL mm	Male inches	WRAPPED
1/4"	25	1/4	ADP14-25



Adaptor - 1/4" Hex Drive to 1/4" Square Drive

1/4" HEX TO SQUARE ADAPTOR			
Square inches	OAL mm	Male inches	WRAPPED
1/4"	65	1/4	ADP14-65
	75	1/4	ADP14-75
	100	1/4	ADP14-100
	150	1/4	ADP14-150
	75	3/8	ADP38-75
	70	1/2	ADP12-70



3 PCE Hex to Square Adapter Set Imperial

Sizes: 1/4, 3/8 & 1/2"

Code: 42191

Bit Holders & Screwdriver Handle

Bit Holder



2 Piece Magnetic Bit Holder
1/4" with 'C' ring

1/4" MAGNETIC BIT HOLDER - 2 PCE

Size	OAL mm	Body ø mm	WRAPPED 10 per strip	CARDED 1 per card
1/4"	54	11	MBHC54	
	75	11	MBHC75	CMBHC75
	150	11	MBHC150	

Size	OAL mm	Body ø mm	WRAPPED 1 piece	CARDED 1 per card
1/4"	300	11	MBHC300	

Bit Holder



1 Piece Magnetic Bit Holder
1/4" with 'C' ring

HEAVY DUTY
1 piece
Stainless Steel

1/4" MAGNETIC BIT HOLDER - 1 PCE

Size	OAL mm	Body ø mm	WRAPPED 10 per strip	CARDED 1 per card
1/4"	54	11.2	MBHCS54	CMBHCS54
	75	11.2	MBHCS75	CMBHCS75



1 Piece Magnetic
Reduced Head Bit Holder
1/4" with 'C' ring

HEAVY DUTY
1 piece
Stainless Steel

1/4" MAGNETIC BIT HOLDER - 1 PCE - REDUCED HEAD

Size	OAL mm	Body ø mm	WRAPPED 1 piece	CARDED 1 per card
1/4"	75	10.4	MBHCS75R	

Bit Holder



Square Drive to 1/4" Bit Holder
with 'C' ring

1/4" MAGNETIC BIT HOLDER - 2 PCE

Square Drive ø inches	OAL mm	Body ø mm	WRAPPED 10 per strip	CARDED 1 per card
3/8"	38	19	BH38-14	
1/2"	45	25	BH12-14	

Bit Holder



Professional Magnetic Bit Holder
1/4" with spring loaded quick release

1/4" MAGNETIC BIT HOLDER - QUICK RELEASE

Size	OAL mm	Body ø mm	WRAPPED 10 per strip	CARDED 1 per card
1/4"	65	16		CMBHQR65
	150	16		CMBHQR150

4 in 1 Insulated Screwdriver Handle



HEAVY DUTY
& light weight



Shock proof 2000 volts UL tested

4 Insert bits included:

- ⊕ 2 x Phillips® - PH1 & PH2
- ⊖ 2 x Slotted - SL5 & SL6

Code: 68888

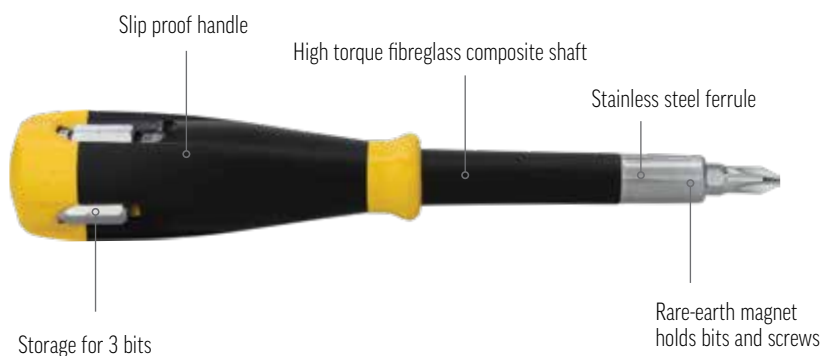

33 PCE

BIT BOY Insert Bit Set

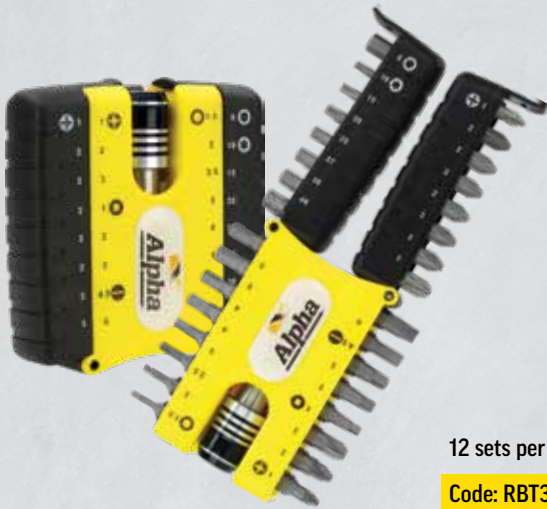

Innovative and compact folding case with belt clip

CONTAINS:
1 x Bit Holder and
32 x Insert bits:

- ⊕ 8 x Phillips®
- ✱ 3 x Pozidriv®
- 3 x Square
- ⊖ 2 x Slotted
- ⬢ 9 x Hex
- ⊕ 7 x Torx®

12 sets per counter display

Code: RBT33



100 PCE Security Bit Set



Moulded Plastic Box
1/4" Hex Drive Assorted
Security and Driver Bits

CONTAINS:

- 1 x 1/4" Sq. x 1/4" Hex x 1" Ext.
- 1 x 1/4" Sq. x 1/4" Hex x 2" Ext.
- 1 x Magnetic Bit Holder
- 1 x Socket Bit Holder
- 1 x Wing Nut Driver

Code: EW-100

- ⊕ 8 x Phillips®
- ✱ 8 x Pozidriv®
- 4 x Square
- ⊖ 9 x Slotted
- ⬢ 10 x Hex (imperial)
- ⬢ 9 x Hex (metric)
- ⬢ 6 x Hex Security (imperial)
- ⬢ 6 x Hex Security (metric)
- ⬢ 4 x Tri-wing®
- ⬢ 4 x Pin Security
- ⬢ 9 x Torx®
- ⬢ 9 x Torx® Security
- ⬢ 3 x Torq-set®
- ⬢ 3 x Spline
- ⬢ 3 x Clutch

33 PCE

Security Bit Set

Moulded Plastic Case
1/4" Hex Drive Assorted
Security and Driver Bits
Carded

Code: 42133



CONTAINS:

1 x Bit Holder and
32 x Insert bits:

- ⊕ 4 x Phillips®
- ⬢ 6 x Hex Security (metric)
- ⬢ 6 x Hex Security (imperial)
- ⬢ 4 x Pin Security
- ⬢ 9 x Torx® Security
- ⊕ 3 x Torq-set®



Small Bulk Driver Merchandiser

13 SKUS
240 items

- Compact counter display of the most common driver bits
- Lockable cover and rear storage compartment

Size (mm):
180 W x 340 H x 400 D

DESCRIPTION	ITEM	CODE	QTY
Phillips® Insert Bit	PH1 x 25	PH125S	10
	PH2 X 25	PH225S	30
Phillips® Power Bit	PH2 x 50	PH250S	30
	PH2 x 75	PH275S	30
	PH2 x 65 D/E	PH265D	20
	PH2 x 150	PH2150S	10
Slotted Insert Bit	SL6 x 25	SL625S	20
Square Power Bit	SQ2 x 50	SQ250S	10
Hex Insert Bit	HEX5 x 30	HEX530S	20
Pozidriv® Insert Bit	PZ2 x 25	PZ225S	20
Magnetic Bit Holder with C Ring	1/4" x 75	MBHC75	10
Nutsetter	5/16" x 65	NS51665	20
	3/8" x 65	NS3865	10

Code: SML/BIT



Large Bulk Driver Merchandiser

25 SKUS
410 items

- Pull out stock drawer runs on ball bearing slides, providing easy access
- Clearly labelled compartments
- Clear fold up lockable perspex lid
- Full product identification and barcoding on rear
- Compact footprint

Size (mm): 405 W x 410 H x 490 D



Merchandiser contains individually wrapped bits with item code, barcode and branding

DESCRIPTION	ITEM	CODE	QTY
Phillips® Insert Bit	PH2 x 25	PH225S	30
	PH1 x 50	PH150S	10
Phillips® Power Bit	PH2 x 50	PH250S	30
	PH2 x 75	PH275S	30
	PH2 x 100	PH2100S	20
	PH2 x 150	PH2150S	10
Phillips® Double Ended	PH2 x 45	PH245D	20
	PH2 x 65	PH265D	20
	PH2 x 150	PH2150D	10
Pozidriv® Insert Bit	PZ2 x 25	PZ225S	20
Pozidriv® Power Bit	PZ2 x 50	PZ250S	20
Square Power Bit	SQ1 x 50	SQ150S	10
	SQ2 x 50	SQ250S	10
	SQ3 x 50	SQ350S	10
Hex Insert Bit	HEX5 x 30	HEX530S	20
Slotted Insert Bit	SL6 x 25	SL625S	20
Torx® Power Bit	T20 x 50	TX2050S	10
	T30 x 50	TX3050S	10
Nutsetter	1/4" x 42	NS1442	10
	5/16" x 42	NS51642	20
	5/16" x 65	NS51665	20
	3/8" x 42	NS3842	10
Adapter Hex to Square	3/8" x 65	NS3865	10
	1/4" - 1/4" x 65	ADP14-65	20
Magnetic Bit Holder with C Ring	1/4" x 75	MBHC75	10

Code: LGE/BIT

Maxi Bulk Driver Merchandiser



39 SKUS
840 items

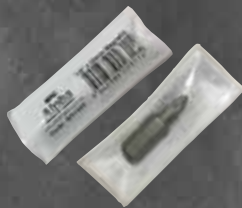

Merchandiser contains individually wrapped bits with item code, barcode and branding

- Pull out stock drawers run on ball bearing slides, providing easy access
- Clearly labelled compartments
- Clear fold-up perspex lid
- Combination lock supplied for security
- Full product identification and barcoding on back of merchandiser

Size (mm): 405 W x 580 H x 480 D

DESCRIPTION	ITEM	CODE	QTY
Phillips® Insert Bit	PH2 x 25	PH225S	50
	PH1 x 50	PH150S	20
	PH2 x 50	PH250S	50
Phillips® Power Bit	PH2 x 75	PH275S	30
	PH2 x 100	PH2100S	30
	PH2 x 150	PH2150S	20
	PH3 x 50	PH350S	10
	PH2 x 45	PH245D	20
Phillips® Double Ended	PH2 x 65	PH265D	20
	PH2 x 100	PH2100D	30
	PH2 x 150	PH2150D	20
Phillips® Ribbed Insert Bit	PH2 x 25	PH225SR	30
Phillips® Ribbed Power Bit	PH2 x 50	PH250SR	30
	PH2 x 75	PH275SR	20
Pozidriv® Insert Bit	PZ2 x 25	PZ225S	20
Pozidriv® Power Bit	PZ2 x 50	PZ250S	20
	SQ1 x 25	SQ125S	20
Square Insert Bit	SQ2 x 25	SQ225S	30
	SQ3 x 25	SQ325S	20
	SQ1 x 50	SQ150S	20
Square Power Bit	SQ2 x 50	SQ250S	30
	SQ2 x 75	SQ275S	20
	SQ3 x 50	SQ350S	20
Hex Insert Bit	HEX5 x 30	HEX530S	20
Hex Power Bit	HEX5 x 50	HEX550S	30
Slotted Power Bit	SL6 x 50	SL650S	10
Torx® Power Bit	T15 x 50	TX1550S	10
	T20 x 50	TX2050S	10
	T25 x 50	TX2550S	10
	T30 x 50	TX3050S	10
	T40 x 50	TX4050S	10
Nutsetter	1/4" x 42	NS1442	20
	5/16" x 42	NS51642	20
	5/16" x 65	NS51665	20
	3/8" x 42	NS3842	20
Adapter Hex to Square	3/8" x 65	NS3865	20
	1/4" - 1/4" x 75	ADP14-75	10
Magnetic Bit Holder with C Ring	1/4" x 54	MBHC54	30
	1/4" x 75 S/S	MBHCS75	10

Code: MAX/BIT



Reference Tables



Drill Size & Decimal Equivalent

Metric	Fraction	Gauge	Inch
0.300			0.0118
0.320			0.0126
0.343		80	0.0135
0.350			0.0138
0.368		79	0.0145
0.380			0.0150
0.397	1/64"		0.0156
0.400			0.0157
0.406		78	0.0160
0.420			0.0165
0.450			0.0177
0.457		77	0.0180
0.480			0.0189
0.5			0.0197
0.508		76	0.0200
0.520			0.0205
0.533		75	0.0210
0.550			0.0217
0.572		74	0.0225
0.580			0.0228
0.600			0.0236
0.610		73	0.0240
0.620			0.0244
0.635		72	0.0250
0.650			0.0256
0.660		71	0.0260
0.680			0.0268
0.700			0.0276
0.711		70	0.0280
0.720			0.0283
0.742		69	0.0292
0.750			0.0295
0.780			0.0307
0.787		68	0.0310
0.794	1/32"		0.0312
0.800			0.0315
0.813		67	0.0320
0.820			0.0323
0.838		66	0.0330
0.850			0.0335
0.880			0.0346
0.889		65	0.0350
0.900			0.0354
0.914		64	0.0360
0.920			0.0362
0.940		63	0.0370
0.950			0.0374
0.965		62	0.0380
0.980			0.0386
0.990		61	0.0390
1.0			0.0394
1.016		60	0.0400
1.041		59	0.0410
1.050			0.0413
1.067		58	0.0420
1.092		57	0.0430
1.100			0.0433
1.150			0.0453
1.181		56	0.0465
1.191	3/64"		0.0469
1.200			0.0472
1.250			0.0492

Metric	Fraction	Gauge	Inch
1.300			0.0512
1.321		55	0.0520
1.350			0.0531
1.397		54	0.0550
1.400			0.0551
1.450			0.0571
1.5			0.0591
1.511		53	0.0595
1.550			0.0610
1.588	1/16"		0.0625
1.600			0.0630
1.613		52	0.0635
1.650			0.0650
1.700			0.0669
1.702		51	0.0670
1.750			0.0689
1.778		50	0.0700
1.800			0.0709
1.850			0.0728
1.854		49	0.0730
1.900			0.0748
1.930		48	0.0760
1.950			0.0768
1.984	5/64"		0.0781
1.994		47	0.0785
2.0			0.0787
2.050			0.0807
2.057		46	0.0810
2.083		45	0.0820
2.100			0.0827
2.150			0.0846
2.184		44	0.0860
2.200			0.0866
2.250			0.0886
2.610		43	0.0890
2.300			0.0906
2.350			0.0925
2.375		42	0.0935
2.381	3/32"		0.0938
2.400			0.0945
2.438		41	0.0960
2.450			0.0965
2.489		40	0.0980
2.5			0.0984
2.527		39	0.0995
2.550			0.1004
2.578		38	0.1015
2.600			0.1024
2.642		37	0.1040
2.650			0.1043
2.700			0.1063
2.705		36	0.1065
2.750			0.1083
2.778	7/64"		0.1094
2.794		35	0.1100
2.800			0.1102
2.819		34	0.1110
2.850			0.1122
2.870		33	0.1130
2.900			0.1142
2.946		32	0.1160
2.950			0.1161

Metric	Fraction	Gauge	Inch
3.0			0.1181
3.048		31	0.1200
3.100			0.1220
3.175	1/8"		0.1250
3.200			0.1260
3.250			0.1280
3.264		30	0.1285
3.300			0.1299
3.400			0.1339
3.454		29	0.1360
3.5			0.1378
3.569		28	0.1405
3.572	9/64"		0.1406
3.600			0.1417
3.658		27	0.1440
3.700			0.1457
3.734		26	0.1470
3.750			0.1476
3.797		25	0.1495
3.800			0.1496
3.861		24	0.1520
3.900			0.1535
3.912		23	0.1540
3.969	5/32"		0.1562
3.988		22	0.1570
4.0			0.1575
4.039		21	0.1590
4.089		20	0.1610
4.100			0.1614
4.200			0.1654
4.216		19	0.1660
4.250			0.1673
4.300			0.1693
4.305		18	0.1695
4.366	11/64"		0.1719
4.394		17	0.1730
4.400			0.1732
4.496		16	0.1770
4.600			0.1772
4.572		15	0.1800
4.600			0.1811
4.623		14	0.1820
4.700		13	0.1850
4.750			0.1870
4.762	3/16"		0.1875
4.800		12	0.1890
4.851		11	0.1910
4.900			0.1929
4.915		10	0.1935
4.978		9	0.1960
5.0			0.1969
5.055		8	0.1990
5.100			0.2008
5.105		7	0.2010
5.159	13/64"		0.2031
5.182		6	0.2040
5.200			0.2047
5.220		5	0.2055
5.250			0.2067
5.300			0.2087
5.309		4	0.2090
5.400			0.2126

Metric	Fraction	Gauge	Inch
5.410		3	0.2130
5.5			0.2165
5.556	7/32"		0.2188
5.600			0.2205
5.613		2	0.2210
5.700			0.2244
5.750			0.2264
5.791		1	0.2280
5.800			0.2283
5.900			0.2323
5.944		A	0.2340
5.953	15/64"		0.2344
6.0			0.2362
6.045		B	0.2380
6.100			0.2402
6.147		C	0.2420
6.200			0.2441
6.248		D	0.2460
6.250			0.2461
6.300			0.2480
6.350	1/4"	E	0.2500
6.400			0.2520
6.5			0.2559
6.528		F	0.2570
6.600			0.2598
6.629		G	0.2610
6.700			0.2638
6.747	17/64"		0.2656
6.750			0.2657
6.750		H	0.2660
6.800			0.2677
6.900			0.2717
6.909		I	0.2720
7.0			0.2756
7.036		J	0.2770
7.100			0.2795
7.137		K	0.2810
7.144	9/32"		0.2812
7.200			0.2835
7.250			0.2854
7.300			0.2874
7.366		L	0.2900
7.400			0.2913
7.493		M	0.2950
7.5			0.2953
7.541	19/64"		0.2969
7.600			0.2992
7.671		N	0.3020
7.700			0.3031
7.750			0.3051
7.800			0.3071
7.900			0.3110
7.938	5/16"		0.3125
8.0			0.3150
8.026		O	0.3160
8.100			0.3189
8.200			0.3228
8.204		P	0.3230
8.250			0.3248
8.300			0.3268
8.334	21/64"		0.3281
8.400			0.3307

Drill Size & Decimal Equivalent

Metric	Fraction	Gauge	Inch
8.433		Q	0.3320
8.5			0.3346
8.600			0.3386
8.611		R	0.3390
8.700			0.3425
8.731	11/32"		0.3438
8.750			0.3445
8.800			0.3465
8.839		S	0.3480
8.900			0.3504
9.0			0.3543
9.093		T	0.3580
9.100			0.3583
9.128	23/64"		0.3594
9.200			0.3622
9.250			0.3642
9.300			0.3661
9.347		U	0.3680
9.400			0.3701
9.5			0.3740
9.525	3/8"		0.3750
9.576		V	0.3770
9.600			0.3780
9.700			0.3819
9.750			0.3839
9.800			0.3858
9.804		W	0.3860
9.900			0.3898
9.922	25/64"		0.3906
10.0			0.3937
10.084		X	0.3970
10.100			0.3976
10.200			0.4016
10.250			0.4035
10.262		Y	0.4040
10.300			0.4055
10.319	13/32"		0.4062
10.400			0.4094
10.490		Z	0.4130
10.5			0.4134
10.600			0.4173
10.700			0.4213
10.716	27/64"		0.4219
10.750			0.4232
10.800			0.4252
10.900			0.4291
11.0			0.4331
11.100			0.4370
11.112	7/16"		0.4375
11.200			0.4409
11.250			0.4429
11.300			0.4449
11.400			0.4488
11.5			0.4528
11.509	29/64"		0.4531
11.600			0.4567
11.700			0.4606
11.750			0.4626
11.800			0.4646
11.900			0.4685
11.906	15/32"		0.4688
12.0			0.4724

Metric	Fraction	Gauge	Inch
12.100			0.4764
12.200			0.4803
12.250			0.4823
12.300			0.4843
12.303	31/64"		0.4844
12.400			0.4882
12.5			0.4921
12.600			0.4961
12.700	1/2"		0.5000
12.750			0.5020
12.800			0.5039
12.900			0.5079
13.0			0.5118
13.097	33/64"		0.5156
13.100			0.5157
13.200			0.5197
13.250			0.5217
13.300			0.5236
13.400			0.5276
13.494	17/32"		0.5313
13.5			0.5315
13.600			0.5354
13.700			0.5394
13.750			0.5413
13.800			0.5433
13.891	35/64"		0.5469
13.900			0.5472
14.0			0.5512
14.250			0.5610
14.288	9/16"		0.5625
14.500			0.5709
14.684	37/64"		0.5781
14.750			0.5807
15.0			0.5906
15.081	19/32"		0.5937
15.250			0.6004
15.478	39/64"		0.6094
15.500			0.6102
15.750			0.6201
15.875	5/8"		0.6250
16.0			0.6299
16.250			0.6398
16.272	41/64"		0.6406
16.500			0.6496
16.669	21/32"		0.6563
16.750			0.6594
17.0			0.6693
17.066	43/64"		0.6719
17.250			0.6791
17.462	11/16"		0.6875
17.500			0.6890
17.750			0.6988
17.859	45/64"		0.7031
18.0			0.7087
18.250			0.7185
18.256	23/32"		0.7187
18.500			0.7283
18.653	47/64"		0.7344
18.750			0.7382
19.0			0.7480
19.050	3/4"		0.7500
19.250			0.7579

Metric	Fraction	Gauge	Inch
19.447	49/64"		0.7656
19.500			0.7677
19.750			0.7776
19.844	25/32"		0.7813
20.0			0.7874
20.241	51/64"		0.7969
20.250			0.7972
20.500			0.8071
20.638	13/16"		0.8125
20.750			0.8169
21.0			0.8268
21.034	53/64"		0.8281
21.250			0.8366
21.431	27/32"		0.8437
21.500			0.8465
21.750			0.8563
21.828	55/64"		0.8594
22.0			0.8661
22.225	7/8"		0.8750
22.250			0.8760
22.500			0.8858
22.622	57/64"		0.8906
22.750			0.8957
23.0			0.9055
23.019	29/32"		0.9063
23.250			0.9154
23.416	59/64"		0.9219
23.500			0.9252
23.750			0.9350
23.812	15/16"		0.9375
24.0			0.9449
24.209	61/64"		0.9531
24.250			0.9547
24.500			0.9646
24.606	31/32"		0.9687
24.750			0.9744
25.0			0.9843
25.003	63/64"		0.9844
25.250			0.9941
25.400	1"		1.0000
25.500			1.0039
25.750			1.0138
25.797	1 1/64"		1.0156
26.0			1.0236
26.194	1 1/32"		1.0313
26.250			1.0335
26.500			1.0433
26.591	1 3/64"		1.0469
26.750			1.0531
26.988	1 1/16"		1.0625
27.0			1.0630
27.250			1.0728
27.384	1 5/64"		1.0781
27.500			1.0827
27.750			1.0925
27.781	1 3/32"		1.0937
28.0			1.1024
28.178	1 7/64"		1.1094
28.250			1.1122
28.500			1.1220
28.575	1 1/8"		1.1250
28.750			1.1319

Metric	Fraction	Gauge	Inch
28.972	1 9/64"		1.1406
29.0			1.1417
29.250			1.1516
29.369	1 5/32"		1.1563
29.500			1.1614
29.750			1.1713
29.766	1 11/64"		1.1719
30.0			1.1811
30.162	1 3/16"		1.1875
30.250			1.1909
30.500			1.2008
30.559	1 13/64"		1.2031
30.750			1.2106
30.956	1 7/32"		1.2187
31.0			1.2205
31.250			1.2303
31.353	1 15/64"		1.2344
31.500			1.2402
31.750	1 1/4"		1.2500
32.0			1.2598
32.147	1 17/64"		1.2656
32.500			1.2795
32.544	1 9/32"		1.2813
32.941	1 19/64"		1.2969
33.0			1.2992
33.338	1 5/16"		1.3125
33.500			1.3189
33.734	1 21/64"		1.3281
34.0			1.3386
34.131	1 11/32"		1.3437
34.500			1.3583
34.528	1 23/64"		1.3594
34.925	1 3/8"		1.3750
35.0			1.3780
35.322	1 25/64"		1.3906
35.500			1.3976
35.719	1 13/32"		1.4063
36.0			1.4173
36.116	1 27/64"		1.4219
36.500			1.4370
36.512	1 7/16"		1.4375
36.909	1 29/64"		1.4531
37.0			1.4567
37.306	1 15/32"		1.4687
37.500			1.4764
37.703	1 31/64"		1.4844
38.0			1.4961
38.100	1 1/2"		1.5000
38.497	1 33/64"		1.5156
38.500			1.5157
38.894	1 17/32"		1.5313
39.0			1.5354
39.291	1 35/64"		1.5469
39.500			1.5551
39.688	1 9/16"		1.5625
40.0			1.5748
40.084	1 37/64"		1.5781
40.481	1 19/32"		1.5937
40.500			1.5945
40.878	1 39/64"		1.6094

Holesaw Recommended RPM

Ø mm	Ø inches	RPM					
		Mild Steel	Stainless Steel	Cast Iron	Brass	Aluminium	Wood
14	9/16	580	300	400	790	900	3,000
16	5/8	550	275	365	730	825	3,000
17	11/16	500	250	330	665	750	3,000
19	3/4	460	230	300	600	690	3,000
20		440	220	290	580	660	3,000
21		425	210	280	560	635	3,000
22	7/8	390	195	260	520	585	3,000
24		360	180	240	480	540	2,700
25	1	350	175	235	470	525	2,700
27	1 1/16	325	160	215	435	480	2,700
29	1 1/8	300	150	200	400	450	2,700
30	1 3/16	285	145	190	380	425	2,400
32	1 1/4	275	140	180	360	410	2,400
33	1 5/16	260	135	175	345	390	2,400
35	1 3/8	250	125	165	330	375	2,400
37	1 7/16	240	120	160	315	360	2,400
38	1 1/2	230	115	150	300	345	2,400
40	1 9/16	220	110	145	290	330	2,100
41	1 5/8	210	105	140	280	315	2,100
43	1 11/16	205	100	135	270	305	2,100
44	1 3/4	195	95	130	250	295	2,100
45		190	100	135	270	305	2,100
46	1 13/16	190	95	125	250	285	2,100
48	1 7/8	180	90	120	240	270	2,100
50		170	85	115	230	255	2,000
51	2	170	85	115	230	255	2,000
52	2 1/16	165	80	110	220	245	2,000
54	2 1/8	160	80	105	210	240	2,000
55		155	75	105	210	235	2,000
57	2 1/4	150	75	100	200	225	2,000
59	2 5/16	145	75	95	195	225	2,000
60	2 3/8	140	70	90	190	220	2,000
64	2 1/2	135	65	85	180	205	1,800
65	2 9/16	130	65	85	175	200	1,800
67	2 5/8	130	65	85	170	195	1,800
68		130	65	85	170	195	1,800
70	2 3/4	125	60	80	160	185	1,800
73	2 7/8	120	60	75	160	180	1,800
75		115	55	75	150	170	1,500
76	3	115	55	70	150	170	1,500
79	3 1/8	110	55	70	140	165	1,500

Holesaw Recommended RPM

Ø mm	Ø inches	RPM					
		Mild Steel	Stainless Steel	Cast Iron	Brass	Aluminium	Wood
83	3 1/4	105	50	65	140	155	1,500
86	3 3/8	100	50	65	130	150	1,500
89	3 1/2	95	45	60	130	145	1,200
92	3 5/8	90	45	60	120	140	1,200
95	3 3/4	90	45	60	120	135	1,200
98	3 7/8	90	45	60	120	135	1,200
100		85	40	55	110	120	1,000
102	4	85	40	55	110	130	1,000
104	4 1/8	80	40	55	110	120	1,000
105		80	40	55	110	120	1,000
108	4 1/4	80	40	55	110	120	1,000
111	4 3/8	80	40	50	100	120	1,000
114	4 1/2	75	35	50	100	105	1,000
121	4 3/4	75	35	50	92	95	1,000
127	5	65	30	45	90	90	1,000
140	5 1/2	60	25	40	85	85	800
146	5 3/4	55	25	35	75	75	800
152	6	55	25	35	75	75	800

Drilling Speeds RPM

Cutting Speed m/min									
12 18 24 27 30 43 61 91									
RPM									
Drill ø mm	Stainless Steel	Tool Steel	Cast Iron	Malleable Iron	Medium Carbon Steel	Free Cutting Steel	Aluminium, Brass & Plastic	Wood	Feed per Revolution (mm/rev)
1	2,445	3,667	4,889	5,500	6,112	8,556	12,223	18,335	.05 to .15
2	1,620	2,445	3,259	3,667	4,074	5,704	8,149	12,223	
3	1,222	1,833	2,445	2,750	3,056	4,278	6,112	9,167	
4	978	1,467	1,956	2,200	2,445	3,422	4,889	7,334	
5	815	1,222	1,630	1,833	2,037	2,852	4,074	6,112	
6	654	982	1,309	1,473	1,637	2,292	3,274	4,911	.15 to .25
7	543	815	1,086	1,222	1,358	1,901	2,716	4,074	
8	489	733	978	1,100	1,222	1,711	2,445	3,667	
9	448	672	896	1,008	1,120	1,568	2,241	3,361	
10	407	611	815	917	1,019	1,426	2,037	3,056	
11	349	524	698	786	873	1,222	1,746	2,619	.25 to .35
13	306	458	611	688	764	1,070	1,528	2,292	
14	272	407	543	611	679	951	1,358	2,037	
16	244	367	489	550	611	856	1,222	1,833	
18	222	333	444	500	556	778	1,111	1,667	
19	204	306	407	458	509	713	1,019	1,528	.35 to .45
20	189	224	378	425	473	662	946	1,419	
22	175	262	349	393	437	611	873	1,310	
25	153	229	306	344	382	535	764	1,146	
28	136	204	272	306	340	475	679	1,019	
32	122	183	244	275	306	428	611	917	.45 to .55
35	111	167	222	250	278	389	556	833	
38	102	153	204	229	255	357	509	764	
41	94	141	188	212	235	329	470	705	
44	87	131	175	196	218	306	437	655	
47	81	122	163	183	204	285	407	611	.55 to .65
50	76	115	153	172	191	267	382	573	
57	68	102	136	153	170	238	340	509	
63	61	92	122	138	153	214	306	458	
70	56	83	111	125	139	194	278	417	
76	51	76	102	115	127	178	255	382	

Drilling Practice

The flute form, web thickness and split point of the standard Alpha drills are suitable for most materials producing fine chips. For effective drilling, the rigidity of the drill and work piece are most important. The shorter the flute length the more rigid the drill. Long drills must be adequately supported to reduce vibration.

The following are important in drill use:

- Clamp the work-piece securely
- Select the correct speed and feed
- Use an appropriate coolant or lubrication
- Ensure the shank is securely held. Avoid using worn sockets or drill chucks as the drill may slip during use
- Regrind the point or replace the drill before it dulls, do not force a worn drill
- Deep hole drilling, withdraw frequently to clear the chips, deep holes start at 4 times diameter
- When drilling stainless steel, manganese and high tensile steels, it is recommended to use an automatic feed through out the drilling cycle
- Do not allow the drill to dwell as it will cause work-hardening; use a slower speed and heavier feed on these materials

Tapping Speeds

Material	Hardness Hb	Straight Flute m/min	Through Holes Spiral Point m/min	Blind Holes Spiral Point m/min	Fluteless m/min
Carbon & Alloy Steel					
Mild Steel	<120	12 - 24	15 - 28	12 - 24	20 - 40
Low/Medium Carbon Steel	<200	11 - 20	16 - 24	10 - 18	18 - 35
Higher Carbon Steel	<250	8 - 12	10 - 16	8 - 12	12 - 25
Low Alloy Engineering Steel	<250	6 - 10	8 - 12	6 - 10	8 - 16
Alloy Steel - Heat Treated	>300		3 - 9	3 - 5	
Alloy Steel - Heat Treated	>350	3 - 7	2 - 5		
Stainless Steel					
Free Cutting (magnetic) Ferritic	<250	6 - 10	8 - 12	5 - 9	10 - 16
Austenitic (non-magnetic)	<250		5 - 9	4 - 7	8 - 14
Martensic / Maraging Duplex Alloy			4 - 6	2 - 5	5 - 8
Cast Iron					
Plain Grey Iron - Ferritic Malleable	<150	9 - 15	10 - 16		
Plain SG Iron - Pearlitic Malleable	<250	6 - 12	5 - 9		
Alloy SG Iron NiHard	>250	3 - 5	4 - 8		
Aluminium					
Wrought (soft) & Extruded	<150	15 - 25	25 - 35b	18 - 30	30 - 50
Wrought & Treated	>150	12 - 20	20 - 35b	16 - 25	25 - 40
Cast Low Silicon 5%	<150	10 - 15	15 - 22b	12 - 18	20 - 30
Cast High Silicon 10%	>150	8 - 12	10 - 18b	8 - 16	
Copper					
Pure Copper	<100	6 - 12		9 - 15	14 - 20
Alpha Brass (soft yellow)	<200	24 - 30			20 - 30
Beta Brass	>200	18 - 24			
High Tensile Bronze	<350	8 - 16	9 - 18b	8 - 16	
Nickel					
Pure Nickel	<300	5 - 9	7 - 11	5 - 8	15 - 22
Nickel, Nimonic 75 Hasteloy Alloys	>300		3 - 7		
Nickel, Inconel 718 Alloy			1 - 4		
Titanium					
Pure Titanium	<200	6 - 12	8 - 10	5 - 8	10 - 15
Titanium Alloys	>300		3 - 6	3 - 6	6 - 12

Tapping Chart

METRIC COARSE 60°		
Thread ø mm	Pitch mm	Tapping Drill ø mm
M1.6	0.35	1.25
M2	0.40	1.60
M2.5	0.45	2.05
M3	0.50	2.50
M3.5	0.60	2.90
M4	0.70	3.30
M4.5	0.75	3.70
M5	0.80	4.20
M6	1.00	5.00
M8	1.25	6.80
M10	1.50	8.50
M12	1.75	10.20
M14	2.00	12.00
M16	2.00	14.00
M18	2.50	15.50
M20	2.50	17.50
M22	2.50	19.50
M24	3.00	21.00
M27	3.00	24.00
M30	3.50	26.50
M33	3.50	29.50
M36	4.00	32.00
M42	4.50	37.50
M45	4.50	40.50
M48	5.00	43.00
M52	5.00	47.00
M56	5.50	50.50

METRIC FINE 60°		
Thread ø mm	Pitch mm	Tapping Drill ø mm
MF4	0.50	3.50
MF5	0.50	4.50
MF6	0.75	5.30
MF8	1.00	7.00
MF10**	1.00	9.00
MF10	1.25	8.80
MF12**	1.25	10.80
MF12	1.50	10.50
MF14**	1.25	12.80
MF14	1.50	12.50
MF16*	1.50	14.50
MF18**	1.50	16.50
MF20*	1.50	18.50
MF22	1.50	20.50
MF24	2.00	22.00
MF25*	1.50	23.50
MF32*	1.50	30.50
MF40*	1.50	38.50
MF50*	1.50	48.50

*Metric Conduit **Spark Plug

UNC 60°		
Thread ø	TPI	Tapping Drill ø mm
2G (.086)	56	1.85
3G (.099)	48	2.10
4G (.112)	40	2.30
5G (.125)	40	2.60
6G (.138)	32	2.80
8G (.164)	32	3.40
10G (.190)	24	3.80
12G (.216)	24	4.50
1/4	20	5.10
5/16	18	6.60
3/8	16	8.00
7/16	14	9.40
1/2	13	10.80
9/16	12	12.20
5/8	11	13.50
3/4	10	16.50
7/8	9	19.50
1	8	22.20
1 1/8	7	25.00
1 1/4	7	28.00
1 3/8	6	31.00
1 1/2	6	34.00
1 3/4	5	39.50
2	4.5	45.00

Tapping Chart

UNF 60°		
Thread ø	TPI	Tapping Drill ø mm
3G (.099)	56	2.10
4G (.112)	48	2.35
5G (.125)	44	2.65
6G (.138)	40	2.90
8G (.164)	36	3.50
10G (.190)	32	4.10
12G (.216)	28	4.60
3/16*	32	4.00
1/4	28	5.50
5/16	24	6.90
3/8	24	8.50
7/16	20	9.80
1/2	20	11.50
9/16	18	12.80
5/8	18	14.50
3/4	16	17.50
7/8	14	20.50
1	14	20.50
1*	14	24.00
1 1/8	12	26.50
1 1/4	12	29.50
1 3/8	12	33.01
1 1/2	12	36.00

*UNS

BSW 55°		
Thread ø inches	TPI	Tapping Drill ø mm
1/16*	60	1.20
3/32*	48	1.85
1/8	40	2.55
5/32*	32	3.20
3/16	24	3.70
7/32*	24	4.50
1/4	20	5.10
5/16	18	6.50
3/8	16	7.90
7/16	14	9.30
1/2	12	10.50
9/16	12	12.10
5/8	11	13.50
3/4	10	16.25
7/8	9	19.25
1	8	22.00
1 1/8	7	24.75
1 1/4	7	28.00
1 1/2	6	33.50
1 3/4	5	39.00
2	4.5	44.50

*WHIT. Form

BSPT (Rc Series Pipe Taper) 55°			
Thread ø	TPI	Tapping Drill ø mm	Drill & Reamer mm
Rc 1/16	28	6.40	6.2
Rc 1/8	28	8.40	8.4
Rc 1/4	19	11.20	10.8
Rc 3/8	19	14.75	14.5
Rc 1/2	14	18.25	18.0
Rc 3/4	14	23.75	23.0
Rc 1	11	30.00	29.0
Rc 1 1/4	11	38.50	38.0
Rc 1 1/2	11	44.50	44.0
Rc 2	11	56.00	55.0

NPT & NPTF 60°			
Thread ø	TPI	Tapping Drill ø mm	Drill & Reamer mm
1/16	27	6.30	6.0
1/8	27	8.50	8.2
1/4	18	11.00	10.8
3/8	18	14.50	14.0
1/2	14	18.00	17.5
3/4	14	23.00	23.0
1	11.5	29.00	28.5
1 1/4	11.5	37.50	37.0
1 1/2	11.5	44.00	43.5
2	11.5	55.50	55.0

NPSF 60°		
Thread ø	TPI	Tapping Drill ø mm
1/8	27	8.6
1/4	18	11.3
3/8	18	14.5
1/2	14	18.0

Thread Forming (Fluteless Taps)

METRIC COARSE		
Thread ø mm	Pitch mm	Tapping Drill ø mm
M1	0.25	0.90
M1.1	0.25	1.00
M1.2	0.25	1.10
M1.4	0.30	1.28
M1.6	0.35	1.45
M1.7	0.35	1.55
M1.8	0.35	1.65
M2	0.40	1.80
M2.2	0.45	2.00
M2.3	0.40	2.10
M2.5	0.45	2.30
M2.6	0.45	2.40
M3	0.50	2.80
M3.5	0.60	3.20
M4	0.70	3.70
M5	0.80	4.60
M6	1.00	5.50
M8	1.25	7.40
M10	1.50	9.30
M12	1.75	11.20

UNC		
Thread ø	TPI	Tapping Drill ø mm
1G (.073)	64	1.7
2G (.086)	56	2.0
3G (.099)	48	2.3
4G (.112)	40	2.6
5G (.125)	40	2.9
6G (.138)	32	3.2
8G (.164)	32	3.8
10G (.190)	24	4.4
12G (.216)	24	5.0
1/4	20	5.8
5/16	18	7.3
3/8	16	8.8
7/16	14	10.2
1/2	13	11.7

UNF		
Thread ø	TPI	Tapping Drill ø mm
1G (.073)	72	1.7
2G (.086)	64	2.0
3G (.099)	56	2.3
4G (.112)	40	2.6
5G (.125)	44	2.9
6G (.138)	40	3.2
8G (.164)	36	3.9
10G (.190)	32	4.5
12G (.216)	28	5.1
1/4	28	6.0
5/16	24	7.5
3/8	24	9.0
7/16	20	10.6
1/2	20	12.1

BSW		
Thread ø inches	TPI	Tapping Drill ø mm
1/8	40	2.9
5/32	32	3.6
3/16	24	4.3
1/4	20	5.8
5/16	18	7.3
3/8	16	8.8

BSPF (G Series)		
Thread ø inches	TPI	Tapping Drill ø mm
1/8	28	9.25
1/4	19	12.50
3/8	19	16.00
1/2	14	20.00
5/8	14	22.00
3/4	14	25.50
7/8	14	29.25
1	11	32.00



T: 02 4957 8787 • F: 02 4957 3737 • E: sales@sheffield.com.au
55 Pendlebury Road (PO Box 687) • Cardiff NSW 2285 Australia
sheffield.com.au | alphatools.com.au

